

ELMED

INSTRUMENTS



DENTAL

SERVING HUMANITY SINCE 1908

TABLE OF CONTENTS

ELMED
INSTRUMENTS

EXTRACTING FORCEPS

1-30



PERIODONTIA INSTRUMENTS

60-71



**ROOT SPLINTER
FORCEPS**

31-32



ENAMEL INSTRUMENTS

72



ROOT ELEVATOR

33-49



PROBES AND EXPLORERS

73-76



**COTTON & DRESSING
FORCEPS**

50-53



**EXCAVATOR & ENDODONTIC
INSTRUMENTS**

77-80



SCALERS

54-60



**NERVE INST & AMALGAM
CONDENSERS**

81-83



FILLING INSTRUMENTS

84-92



**SPATULAS FOR PLASTER
AND ALGINATE**

103-104



AMALGAM CARVERS

93-94



IMPLANT SURGERY

105-112



**POLISHING & CARVING
INSTRUMENTS**

95-98



**CROWN & PERIODONTAL
INSTRUMENTS**

113-116



CEMENT SPATULAS

99-100



**BONE FILE AND
BONE CURETTES**

117-119



WAX & PLASTER KNIVES

101-102



**CARTRIDGE SYRINGES
MOUTH MIRRORS & HANDLES**

120-123



TABLE OF CONTENTS

ELMED
INSTRUMENTS

MOUTH GAGS

124-127



SKIN HOOKS

138



CHEEK RETRACTORS

128



NEEDLE HOLDERS

139-141



**TONGUE DEPRESSORS
& TONGUE HOLDING
FORCEPS**

129-132



**DELICATE, OPERATING
AND DISSECTING SCISSORS**

142-150



SCALPEL HANDLES

133-134



**GUM AND TUNGSTEN
CARBIDE SCISSORS**

151-157



**BONE CHISELS & GOUGES
AND BONE CURETTES**

135-137



**CROWN, STITCH AND
MICRO SCISSORS**

158-160



ORTHODONTIC INSTRUMENTS

161



IMPRESSION TRAYS

176-177



**RUBBER DAM CLAMP
& RUBBER DAM PUNCH
FORCEPS**

162-165



ORTHODONTIC PLIERS

178-185



**MATRIX RETAINERS AND
MATRIX BANDS**

166-167



ARTICULATORS

186



AMALGAM CARRIERS

168-169



**INSTRUMENTS TRAYS AND
BOXCES**

187-196



BONE RONGEURS

170-175



Extracting Forceps, English Pattern

ELMED INSTRUMENTS



90-0100-01



Fig. 1



90-0100-02



Fig. 2



90-0100-03



Fig. 3



90-0100-04



Fig. 4



90-0100-07



Fig. 7



90-0100-08



Fig. 5



90-0100-13



Fig. 13



90-0100-17



Fig. 17



90-0100-18



Fig. 18



90-0100-18 A



Fig. 18A



90-0100-19



Fig. 19



90-0100-20



Fig. 20



90-0100-21



Fig. 21N

Extracting Forceps, English Pattern

ELMED INSTRUMENTS



90-0100-22

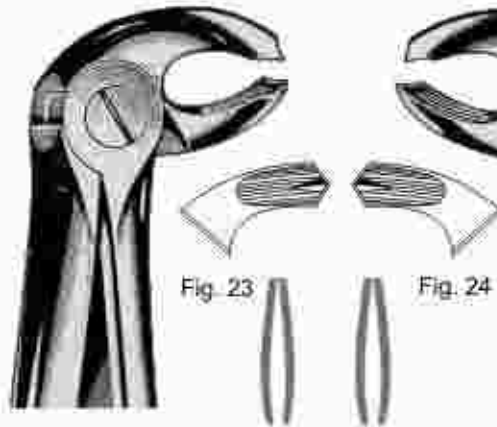

90-0100-23



90-0100-24

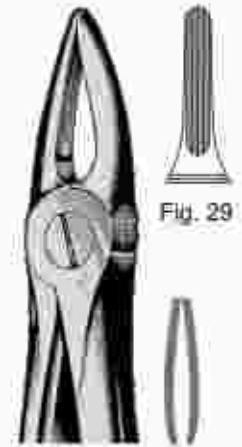

90-0100-29

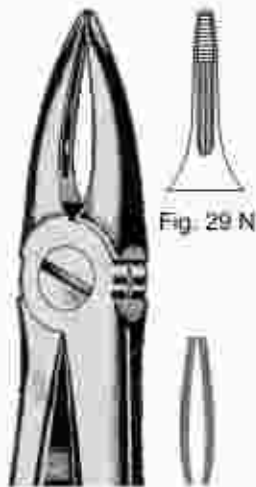

90-0100-29 N

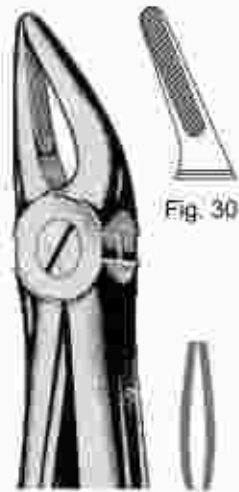

90-0100-30



90-0100-31



90-0100-32



90-0100-33



90-0100-33 A



90-0100-33 B

Extracting Forceps, English Pattern

ELMED
INSTRUMENTS



Fig. 33 1/2

90-0100-33 FG



Fig. 33KA



90-0100-33 KA
KAISER



Fig. 33 1/2 F



90-0100-33 F
FEINER

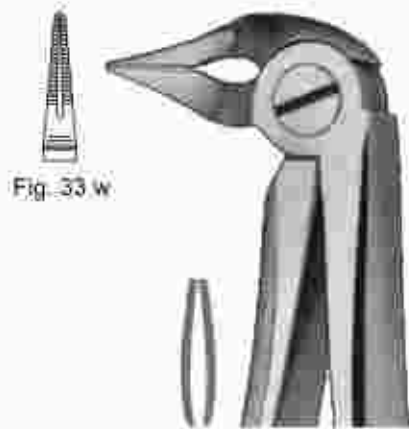

Fig. 33 W

90-0100-33 W



Fig. 34

90-0100-34

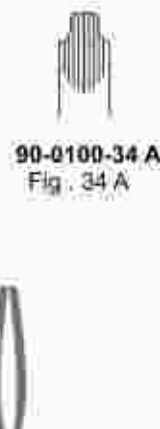

90-0100-34 A
Fig. 34 A



Fig. 34 N

90-0100-34 N

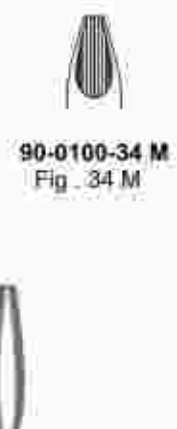

90-0100-34 M
Fig. 34 M

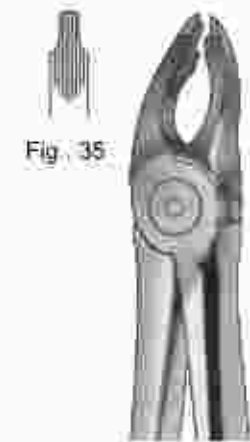
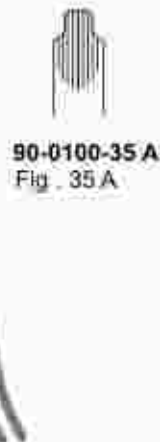

Fig. 35

90-0100-35



90-0100-35 A
Fig. 35 A



Fig. 35 N

90-0100-35 N

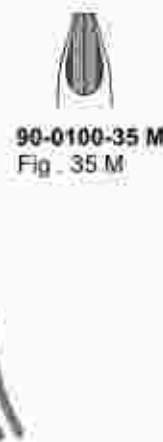

90-0100-35 M
Fig. 35 M



Fig. 36

90-0100-36

Extracting Forceps, English Pattern

ELMED
INSTRUMENTS

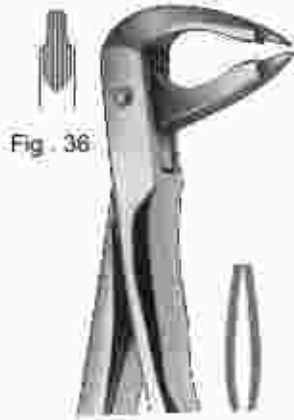

Fig. 36

90-0100-36



90-0100-36 A
Fig. 36 A



Fig. 36

90-0100-36



90-0100-36 A
Fig. 36 A



Fig. 36 N

90-0100-36 N



90-0100-36 M
Fig. 36 M



Fig. 41

90-0100-41



Fig. 44

90-0100-44



90-0100-44 F
Fig. 44 F

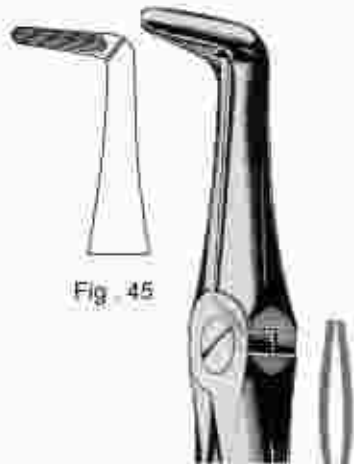

Fig. 45

90-0100-45



90-0100-45 F
Fig. 45 F

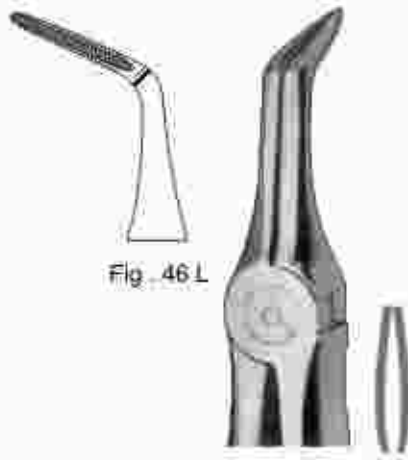

Fig. 46 L

90-0100-46 L



Fig. 46 LX

90-0100-46 LX

Extracting Forceps, English Pattern

ELMED INSTRUMENTS



Fig. 48

90-0100-48



90-0100-49
Fig. 49



Fig. 51

90-0100-51



Fig. 51 A

90-0100-51 A



Fig. 51 C

90-0100-51 C

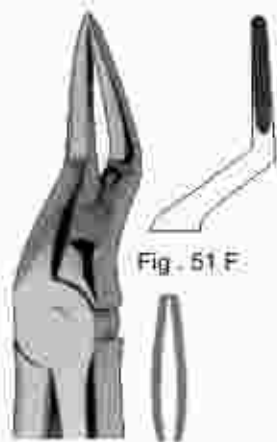

Fig. 51 F

90-0100-51 F
FEINER



Fig. 51 1/2

90-0100-51



Fig. 51 FL

90-0100-51 FL

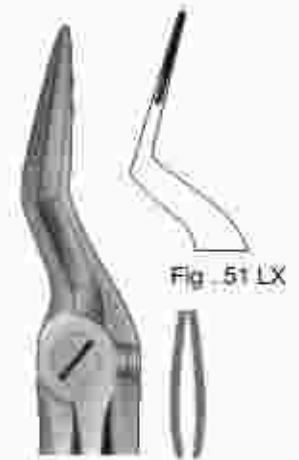

Fig. 51 LX

90-0100-51 LX

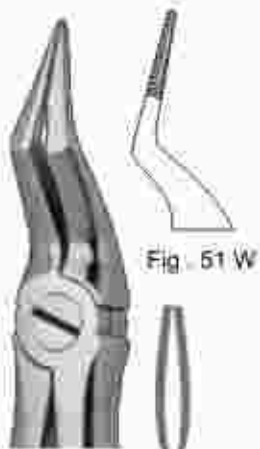

Fig. 51 W

90-0100-51 W



Fig. 51 N

90-0100-51 N

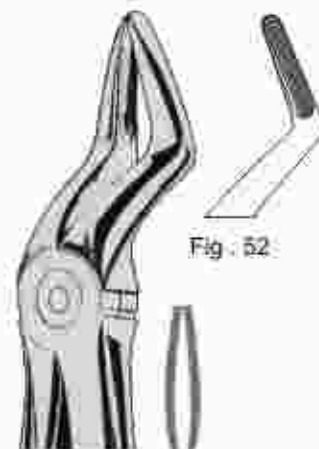

Fig. 52

90-0100-52

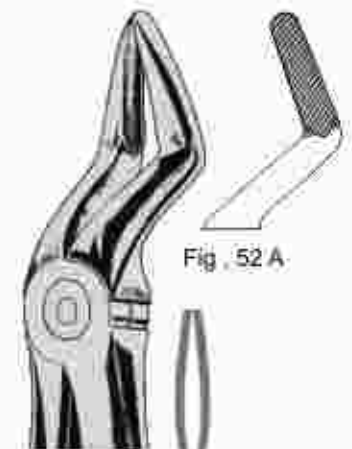

Fig. 52 A

90-0100-52 A

Extracting Forceps, English Pattern

ELMED
INSTRUMENTS



90-0100-53



90-0100-54



90-0100-55



90-0100-56



90-0100-65 L



90-0100-65 R

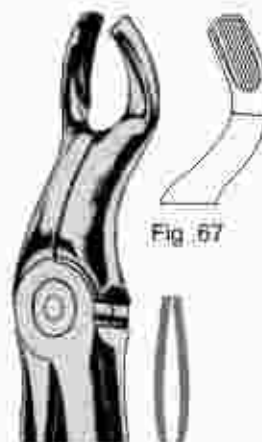

90-0100-67

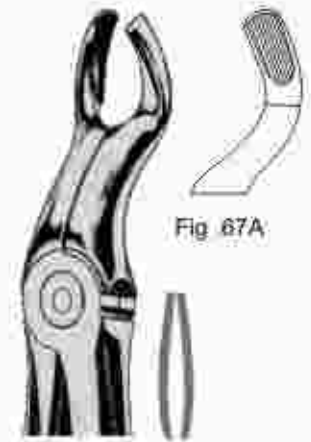

90-0100-67 A



90-0100-67 X

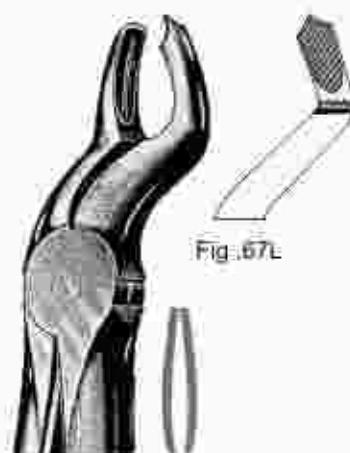

90-0100-67 L

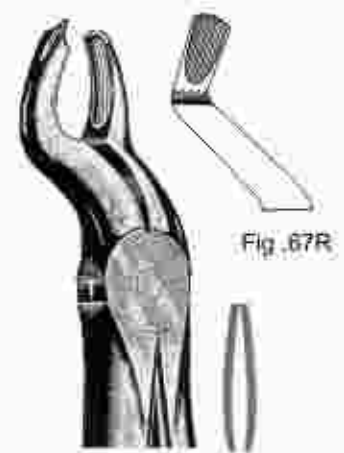

90-0100-67 R

Extracting Forceps, English Pattern

ELMED
INSTRUMENTS



Fig. 67LX

90-0100-67 LX



Fig. 67RX

90-0100-67 RX



Fig. 68

90-0100-68

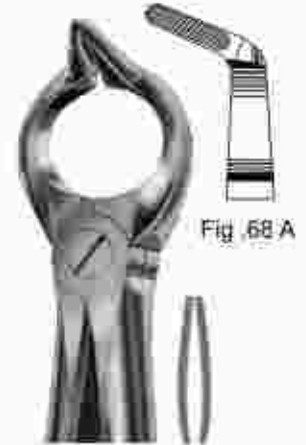

Fig. 68 A

90-0100-68 A



Fig. 73

90-0100-73



Fig. 73 A

90-0100-73 A

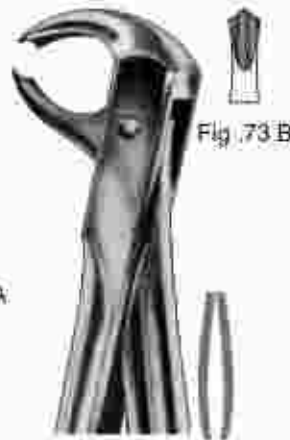

Fig. 73 B

90-0100-73 B



Fig. 73 R

90-0100-73 R



Fig. 73 L

90-0100-73 L



Fig. 73 S

90-0100-73 S

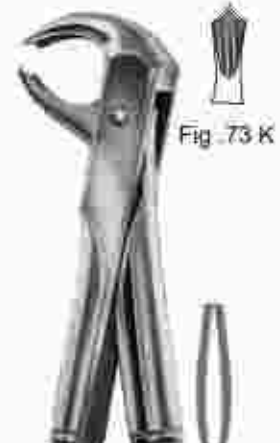
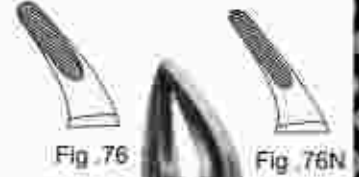
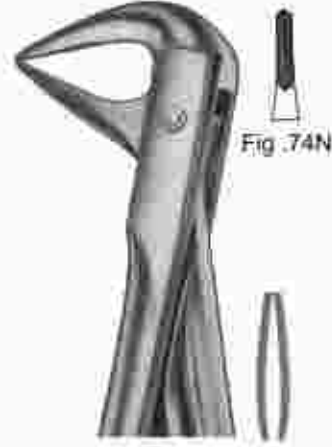

Fig. 73 K

90-0100-73 K

Extracting Forceps, English Pattern

ELMED
INSTRUMENTS



Extracting Forceps, English Pattern

ELMED
INSTRUMENTS



90-0100-79
Fig. 79



90-0100-79 A
Fig. 79 A

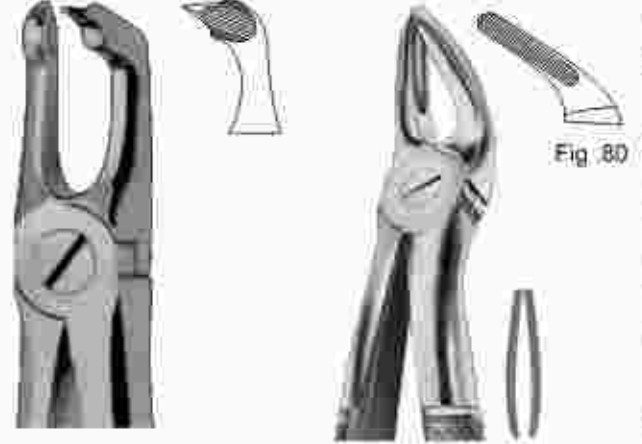

90-0100-80
Fig. 80



90-0100-86 A
Fig. 86 A



90-0100-86 B
Fig. 86 B



90-0100-86 C
Fig. 86 C

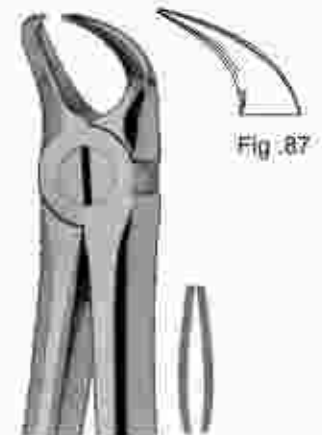

90-0100-87

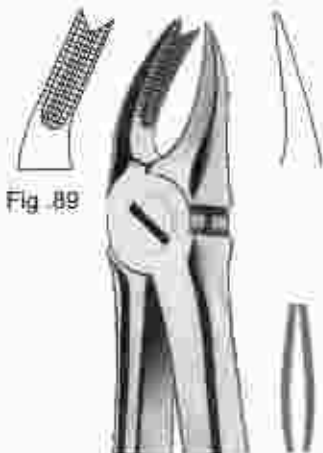

90-0100-89

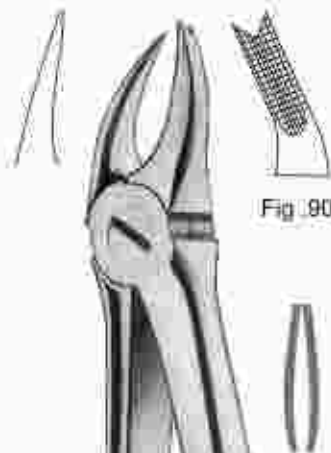

90-0100-90



90-0100-91
Fig. 91
ROWNEY

Extracting Forceps, English Pattern

ELMED INSTRUMENTS



Fig .92

90-0100-92



Fig .93

90-0100-93

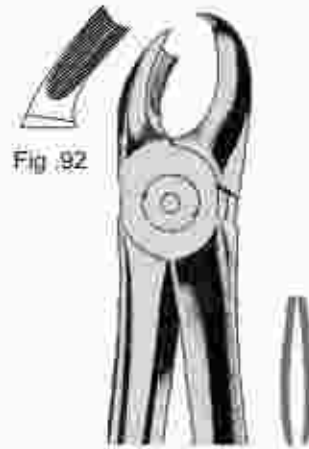

Fig .92

90-0100-92

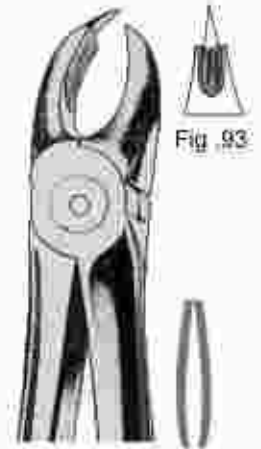

Fig .93

90-0100-93



Fig .94

90-0100-94



Fig .95

90-0100-95



Fig .98

90-0100-98



Fig .99

90-0100-99



Fig .99 1/2

90-0100-99



Fig .99 1/4

90-0100-99



Fig .100

90-0100-100
CAMPEEL



Fig .101

90-0100-101

Extracting Forceps, English Pattern

ELMED INSTRUMENTS



90-0100-102



90-0100-103

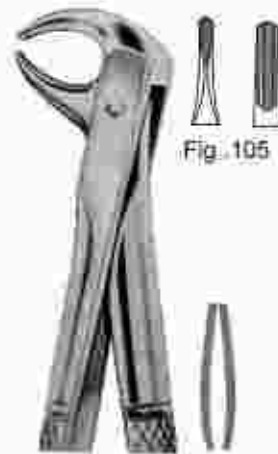

90-0100-105

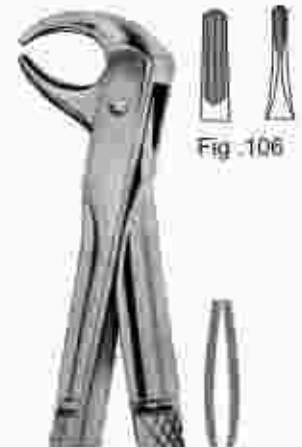

90-0100-106

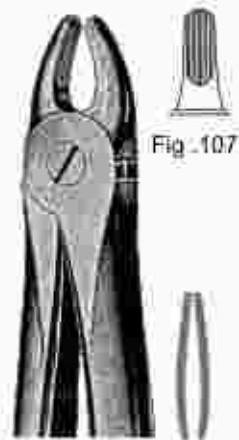

90-0100-107

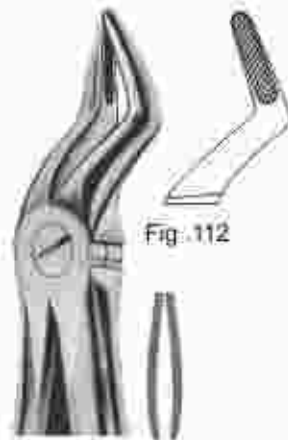

90-0100-112



90-0100-113



90-0100-114



90-0100-123

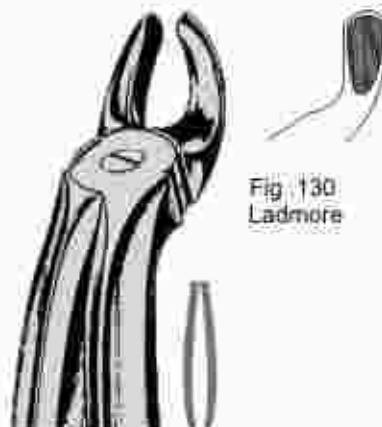

90-0100-130



90-0100-136



90-0100-137

Extracting Forceps, English Pattern

ELMED
INSTRUMENTS



90-0100-143
COLEMAN



90-0100-147
GIBB

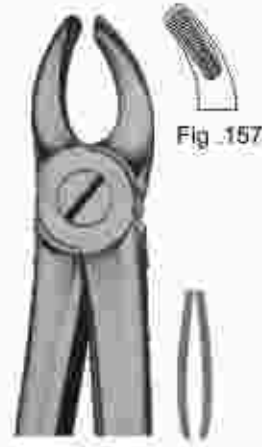

90-0100-157

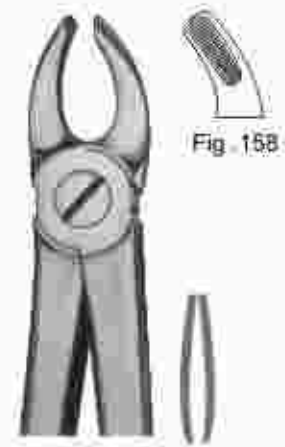

90-0100-158



90-0100-159



90-0100-160



90-0100-161



90-0100-162

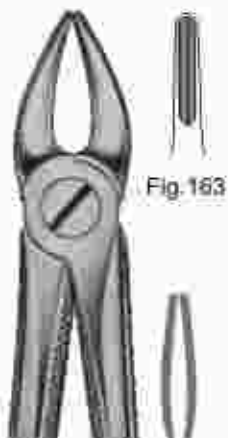

90-0100-163

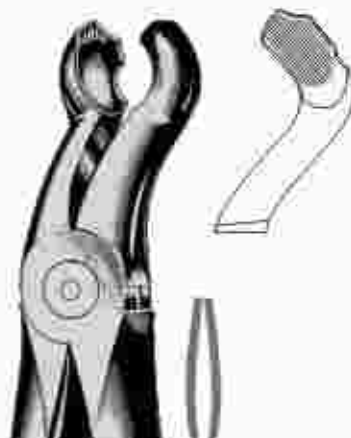

FELSCH



90-0100-22
STIKSA



90-0100-33
STIKSA

Extracting Forceps, English Pattern

ELMED
INSTRUMENTS



90-0100-01



Fig. MD1
MEAD



90-0100-02



Fig. MD2
MEAD



90-0100-03



Fig. MD3
MEAD



90-0100-01

Fig. 1
COHEN



90-0100-4



Fig. MD4
MEAD

Extracting Forceps, English Pattern

ELMED
INSTRUMENTS



90-0100-22 L
Fig. 22 1/2 L
Wisdom routerier



90-0100-22 R
Fig. 22 1/2 R
Wisdom routerier

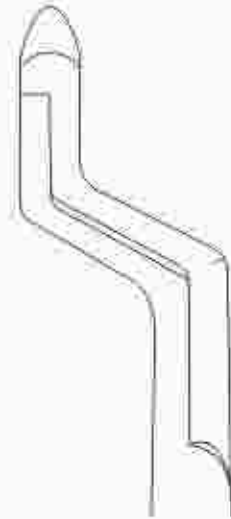
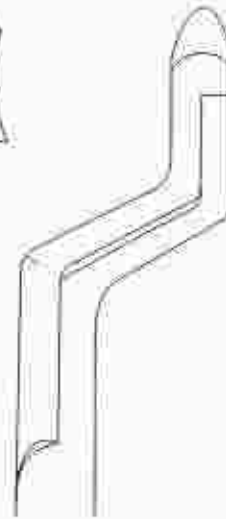

90-0100-149
Fig. 33 1/2 R
Wisdom routerier



90-0100-150
Fig. 33 1/2 L
Wisdom routerier



90-0100-86 L
Fig. 86 1/2 L
Wisdom-routerier



90-0100-86 R
Fig. 86 1/2 R
Wisdom-routerier



90-0100-99 L
Fig. 99 L
Wisdom-routerier



90-0100-99 R
Fig. 99 R
Wisdom-routerier



90-0100-99 L
Fig. 99 1/2 L
Wisdom-routerier



90-0100-99 R
Fig. 99 1/2 R
Wisdom-routerier



Extracting Forceps For Children



Extracting Forceps For Children

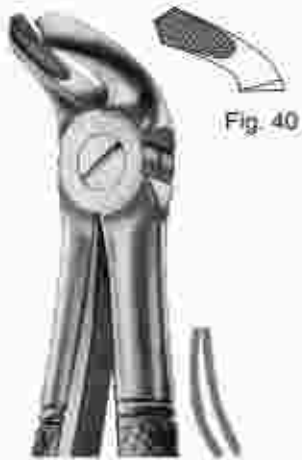

90-0101-40
Fig. 40



90-0101-51 S
Fig. 51S



90-0101-01
Fig. 1



90-0101-02
Fig. 2



90-0101-03
Fig. 3



90-0101-04
Fig. 4



90-0101-05
Fig. 5



90-0101-06
Fig. 6



90-0101-07
Fig. 7

Extracting Forceps, English Pattern

ELMED
INSTRUMENTS



90-0101-196
Fig. 196
KÖHLER



90-0101-198
Fig. 198
KÖHLER



90-0101-199
Fig. 199
KÖHLER

Extracting Forceps, Anatomic Handle

ELMED
INSTRUMENTS



Fig. 1

90-0102-01



Fig. 7

90-0102-07



Fig. 13

90-0102-13

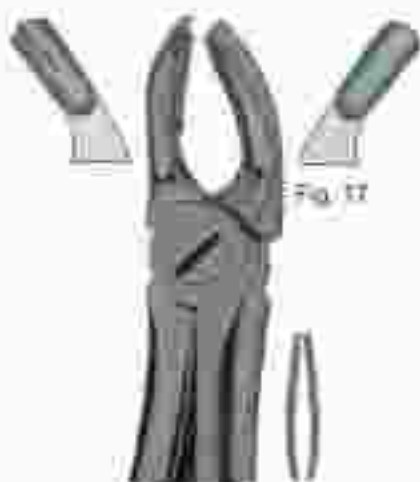

Fig. 17

90-0102-17



Fig. 18

90-0102-18



Fig. 22

90-0102-22



Fig. 33

90-0102-33

Extracting Forceps, Anatomic Handle

ELMED
INSTRUMENTS



90-0102-49



90-0102-51



90-0102-51A



90-0102-57A



90-0102-57



90-0102-48



90-0102-74



90-0102-79

Extracting Forceps, American Pattern

ELMED INSTRUMENTS



90-0103-01
Fig. 1
Standard

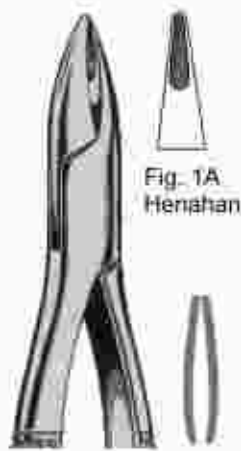

90-0103-01A
Fig. 1A
Henahan

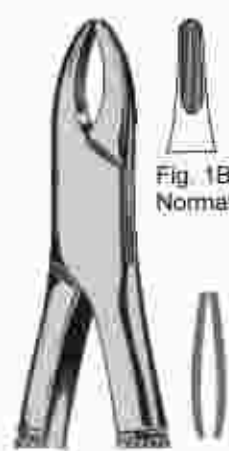

90-0103-1B
Fig. 1B
Normal



90-0103-02
Fig. 2

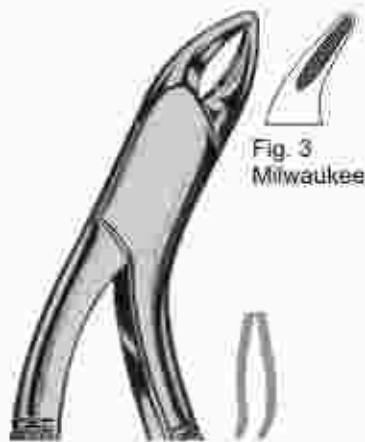

90-0103-03
Fig. 3
Milwaukee



90-0103-3 FH
Fig. 3 FH
Woodward



90-0103-3 FS
Fig. 3 FS
Woodward



Extracting Forceps, American Pattern

ELMED
INSTRUMENTS

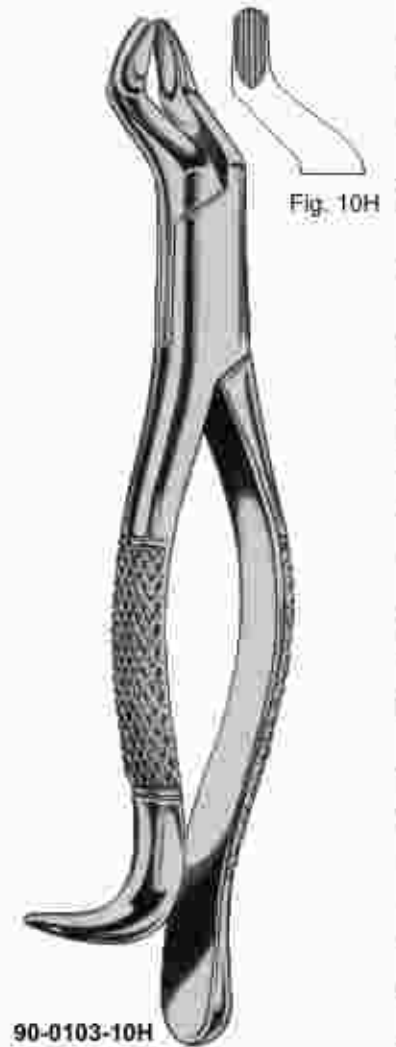
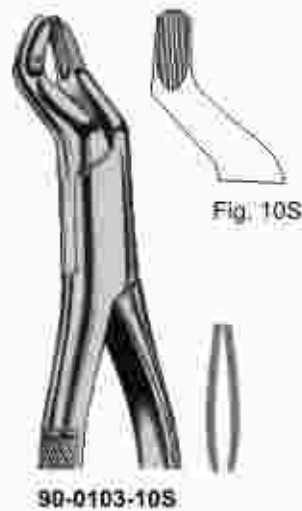
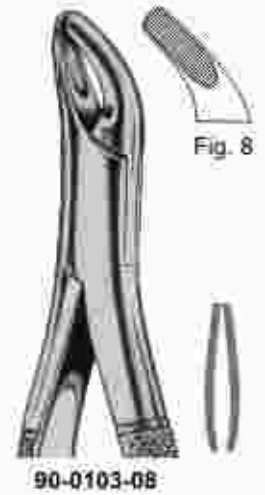
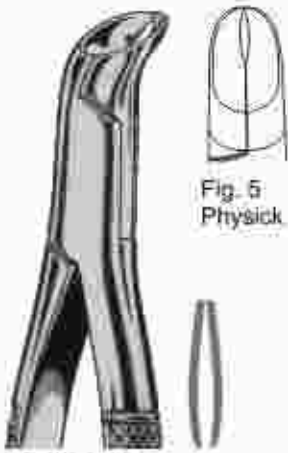

Extracting Forceps, American Pattern

ELMED
INSTRUMENTS



90-0103-13

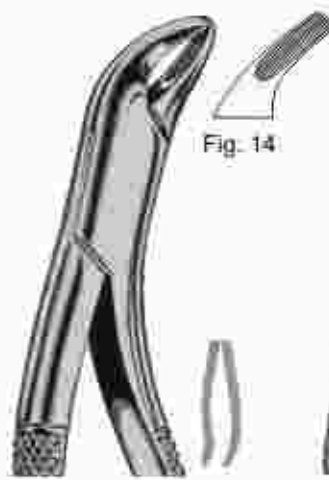

90-0103-14

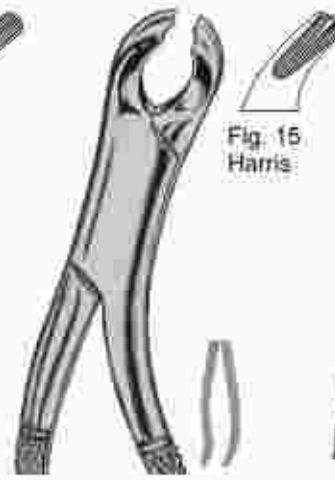

90-0103-15

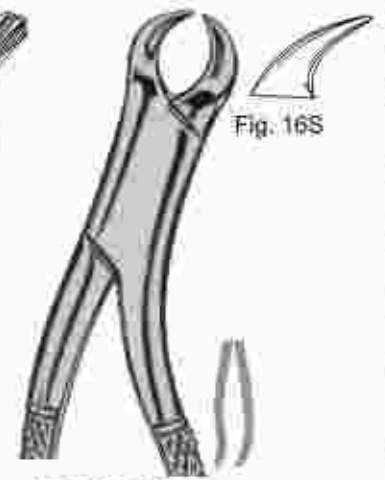

90-0103-16S



90-0103-16

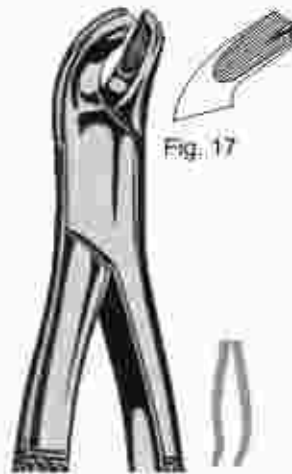

90-0103-17

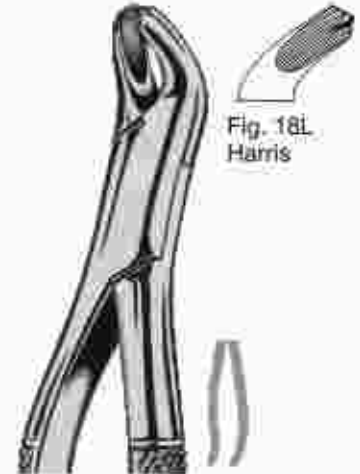

90-0103-18L

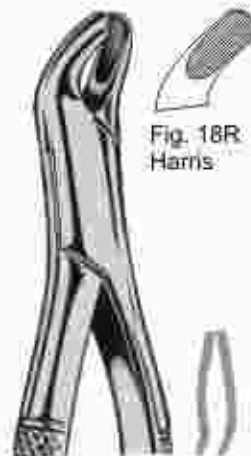

90-0103-18R

Extracting Forceps, American Pattern

ELMED
INSTRUMENTS

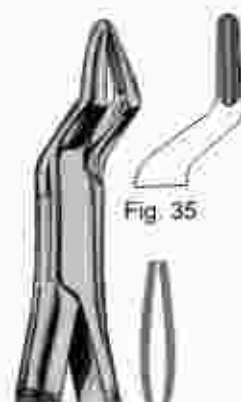
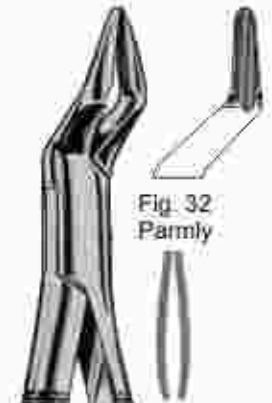
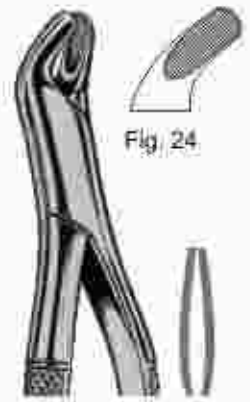
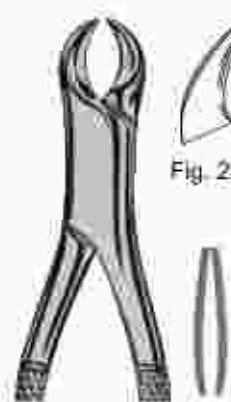

Extracting Forceps, American Pattern

ELMED
INSTRUMENTS

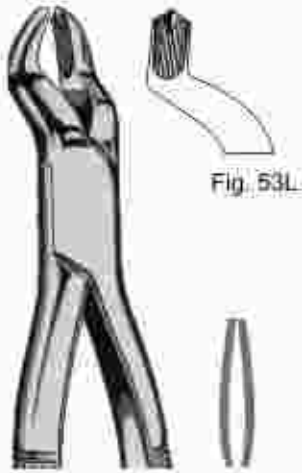

90-0103-53L

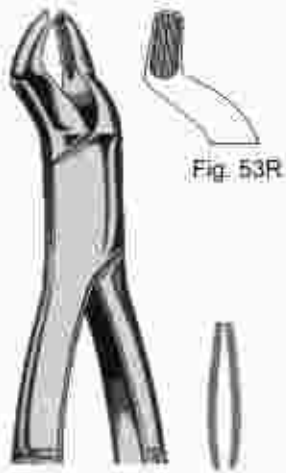

90-0103-53R

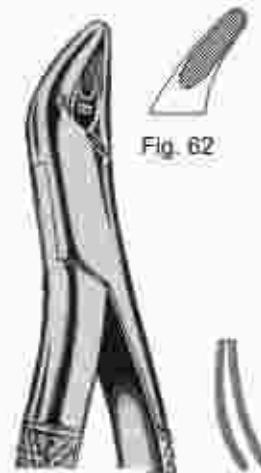

90-0103-62



90-0103-65

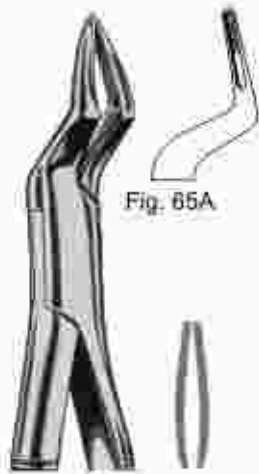

90-0103-65A



90-0103-69

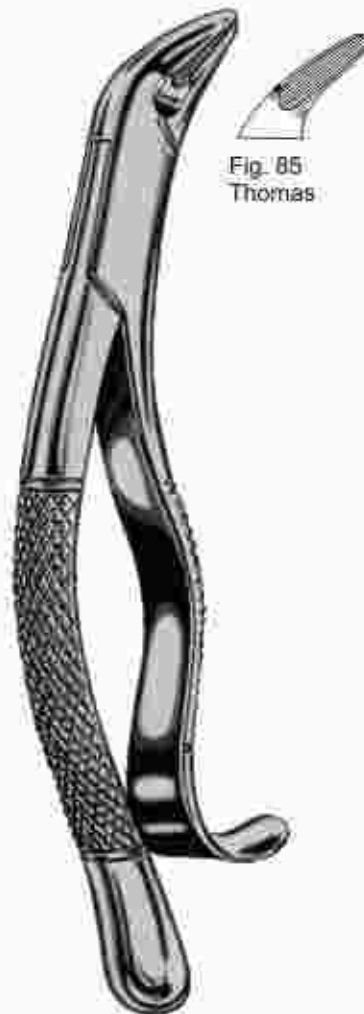

90-0103-85

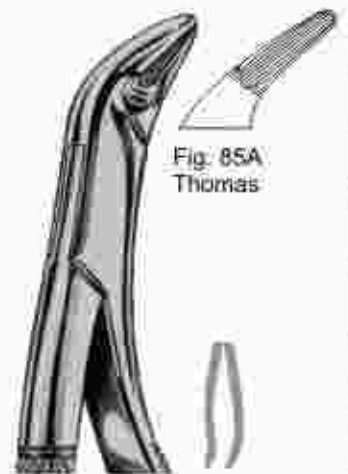

90-0103-85A

Extracting Forceps, American Pattern

ELMED
INSTRUMENTS

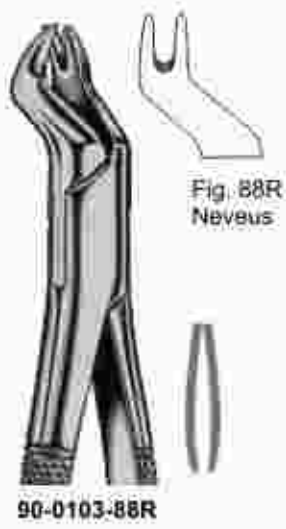

Extracting Forceps, American Pattern

ELMED
INSTRUMENTS



Extracting Forceps, American Pattern

ELMED
INSTRUMENTS

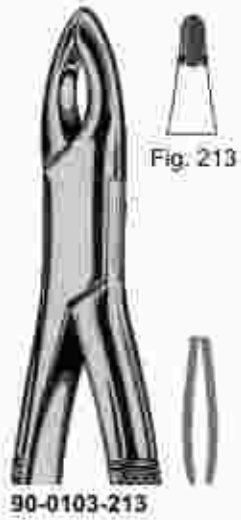
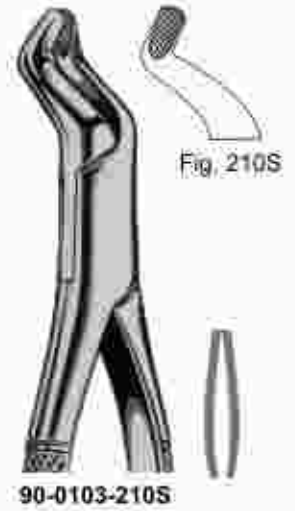
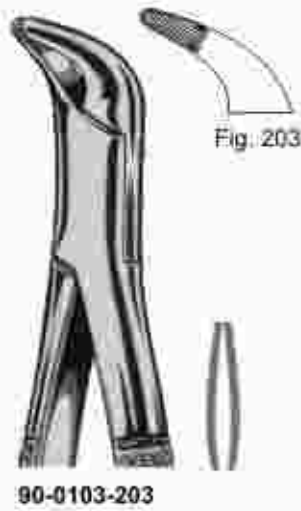
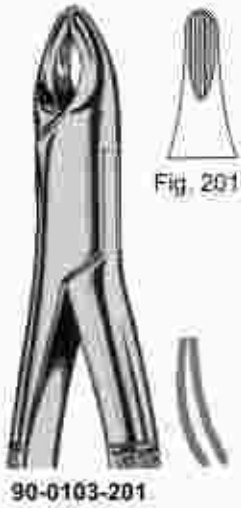

90-0103-210H

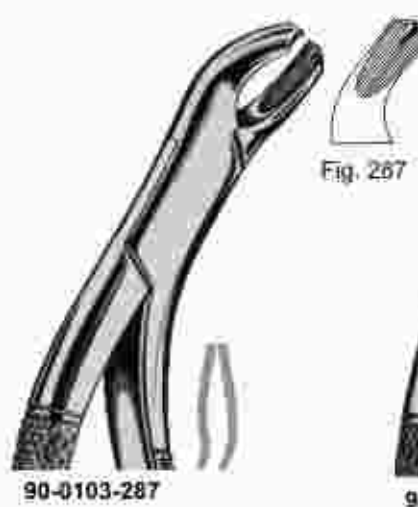
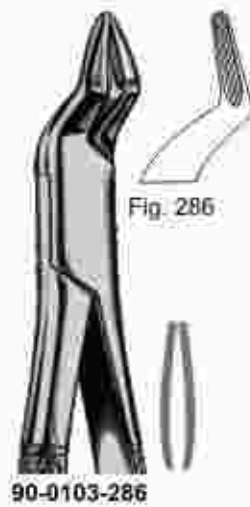

Extracting Forceps, American Pattern

ELMED
INSTRUMENTS



90-0103-109
Cohen

90-0103-109
Cohen



Fig. 150AB

90-0103-150AB



Fig. 151AB

90-0103-151AB



90-0103101AS



Fig. 101AS



90-0103-150AS



Fig. 150AS



90-0103-151AS



Fig. 151AS

Extracting Forceps, American Pattern

ELMED
INSTRUMENTS



Extracting Forceps For Children



90-0104-17-K
Fig. 17-K



90-0104-23-K
Fig. 23-K



90-0104-150-K
Fig. 150-K



90-0104-151-K
Fig. 151-K

Root Splinter Forceps

ELMED
INSTRUMENTS



90-0105-27
WITZEL



90-0105-28
WITZEL



90-0105-29
WITZEL



90-0105-30
WITZEL



90-0105-31
Arthur
14 cm.



90-0105-32
Stieglitz
14 cm.



90-0105-33
Stieglitz
45°
14 cm.



90-0105-34
Stieglitz
90°
14 cm.

Root Splinter Forceps

ELMED
INSTRUMENTS



90-0105-36
Ralks
15 cm



90-0105-35
Ralks
45
15 cm



90-0105-37
Peet
11.5 cm



90-0105-38
14 cm



90-0105-39
14 cm



90-0105-39
Allen
18 cm



90-0105-40
Albrecht
18 cm



90-0105-41
Albrecht
18 cm

Root Elevators

ELMED INSTRUMENTS



91-0106-00
Seldin



91-0106-01
Fig. 1L
Seldin



91-0106-02
Fig. 1R
Seldin



91-0106-03
Fig. 2
Seldin



91-0106-04
Fig. 3
Seldin



91-0106-05
Fig. 3A
Cryer



91-0106-06
Fig. 4L
Seldin



91-0106-07
Fig. 4R
Seldin



91-0107-00
Fig. 6



91-0107-00
Fig. 8



91-0107-00
Fig. 9

Root Elevators

ELMED INSTRUMENTS



91-0108-23
Fig. 301
Apical Standard



91-0108-24
Fig. 302
Apical Standard



91-0108-25
Fig. 303
Apical Standard



91-0108-26
Fig. 304
Apical Standard



91-0109-10
Fig. 10
Miller-Apexo



91-0109-10
Fig. 10
Miller-Apexo

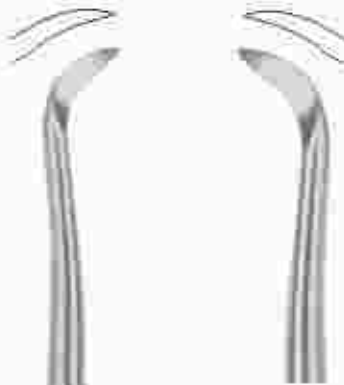

91-0110-00
Fig. 51



90-0110-00
Fig. 50

Root Elevators

ELMED INSTRUMENTS



91-0111-01
Fig. 1
Floh



91-0111-02
Fig. 2
Floh



91-0111-03
Fig. 3
Floh



91-0112-02
Fig. 2
Friedman



91-0112-03
Fig. 3
Friedman



91-0112-01
Fig. 1
Friedman

Root Elevators

ELMED INSTRUMENTS

4.5 mm



91-0113-01
Fig.1
Hylin



3.0 mm



91-0113-02
Fig.2
Hylin



91-0113-03
Fig.3
Hylin



91-0113-04
Fig.4
Hylin

Root Elevators

ELMED INSTRUMENTS

2 mm



91-0114-01
Fig. 1
Bein

3 mm



91-0114-02
Fig. 2
Bein

4 mm



91-0114-03
Fig. 3
Bein

2 mm



91-0114-04
Fig. 4
Bein

3 mm



91-0114-05
Fig. 5
Bein

4 mm



91-0114-06
Fig. 8
Bein

3 mm



91-0114-07
Fig. 7
Bein

4 mm



91-0114-08
Fig. 8
Bein

5.0 mm



91-0114-09
Fig. 1
Bein

4.0 mm



91-0114-10
Fig. 2
Bein

3.5 mm



91-0114-11
Fig. 3
Bein

Root Elevators

ELMED INSTRUMENTS



91-014A-04
Fig.4
Bein



91-0114A-01
Fig.1
Bein



91-014A-02
Fig.2
Bein



91-014A-00
Fig.0
Bein



91-014A-03
Fig.3
Bein



91-0115-01
Fig.1



91-0115-02
Fig.2



91-0115-03
Fig.3



91-0115-04
Fig.4

Root Elevators

ELMED INSTRUMENTS



91-0116-01
Fig.1
Coleman



91-0116-02
Fig.2L
Coleman



91-0116-03
Fig.3R
Coleman



91-0117-01
Fig.1
Coupland



91-0117-02
Fig.2
Coupland



91-0117-03
Fig.3
Coupland

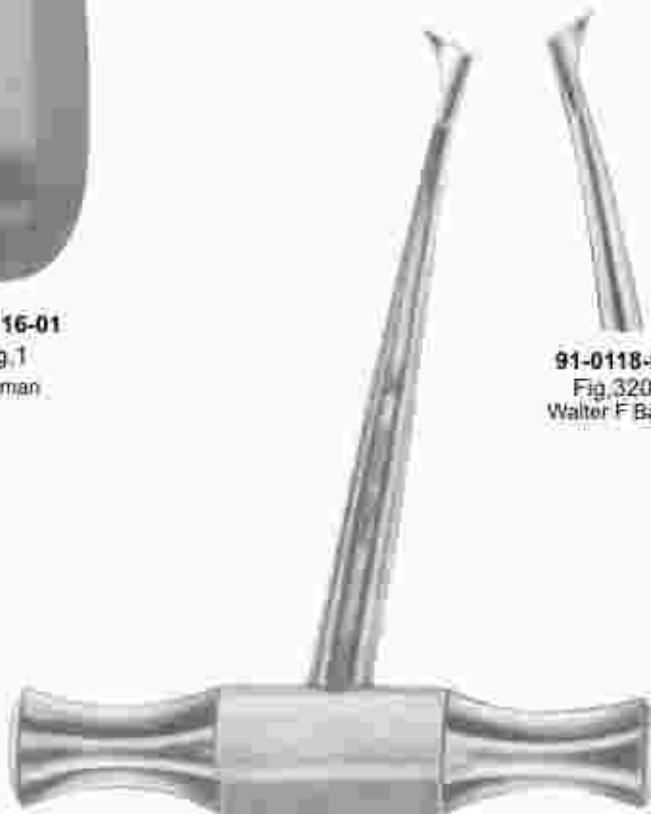

Barry



91-0118-01
Fig.320
Walter F Barry



91-0118-02
Fig.321
Walter F Barry



91-0118-03
Fig.322
Walter F Barry



91-0118-04
Fig.323
Walter F Barry



91-0118-05
Fig.370
Walter F Barry



91-0118-06
Fig.371
Walter F Barry

Root Elevators

ELMED INSTRUMENTS



91-0119-01L
Fig. 1L
Winter



91-0119-01R
Fig. 1R
Winter



91-0119-02L
Fig. 2L
Winter



91-0119-02R
Fig. 2R
Winter



91-0119-11L
Fig. 11L
Winter



91-0119-11R
Fig. 11R
Winter



91-0119-12L
Fig. 12L
Winter



91-0119-12R
Fig. 12R
Winter



91-0119-13L
Fig. 13L
Winter



91-0119-13R
Fig. 13R
Winter



91-0119-14L
Fig. 14L
Winter



91-0119-14R
Fig. 14R
Winter

Root Elevators

ELMED INSTRUMENTS

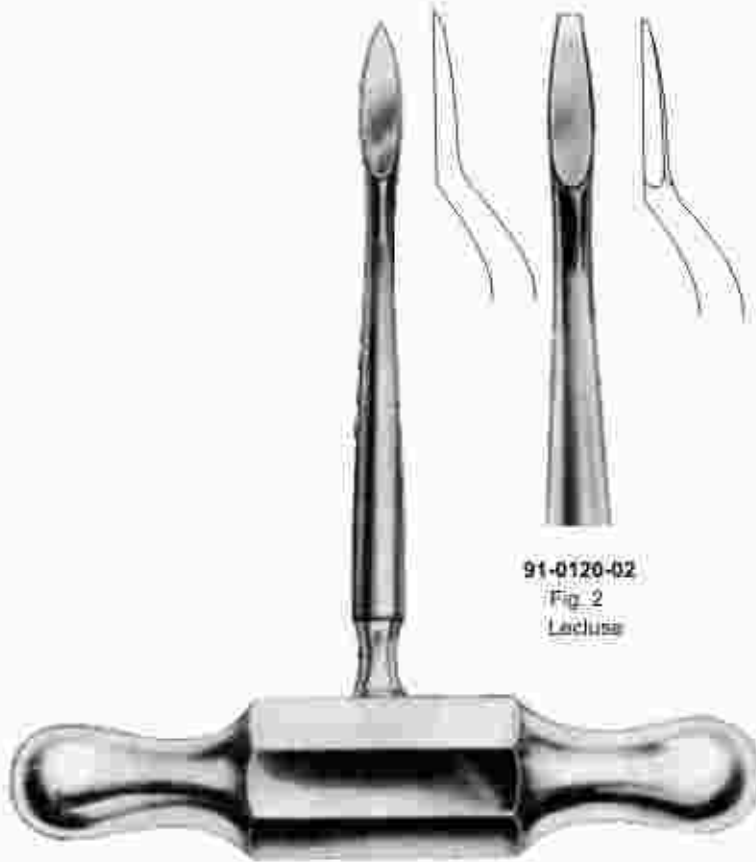

91-0120-01
Fig. 1
Lecluse

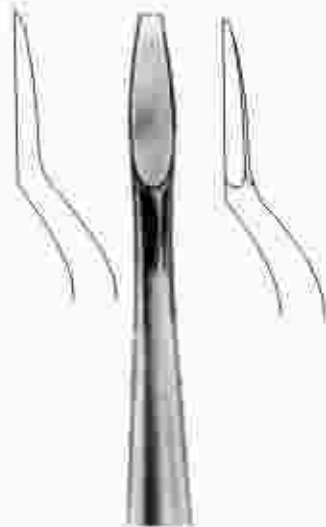

91-0120-02
Fig. 2
Lecluse

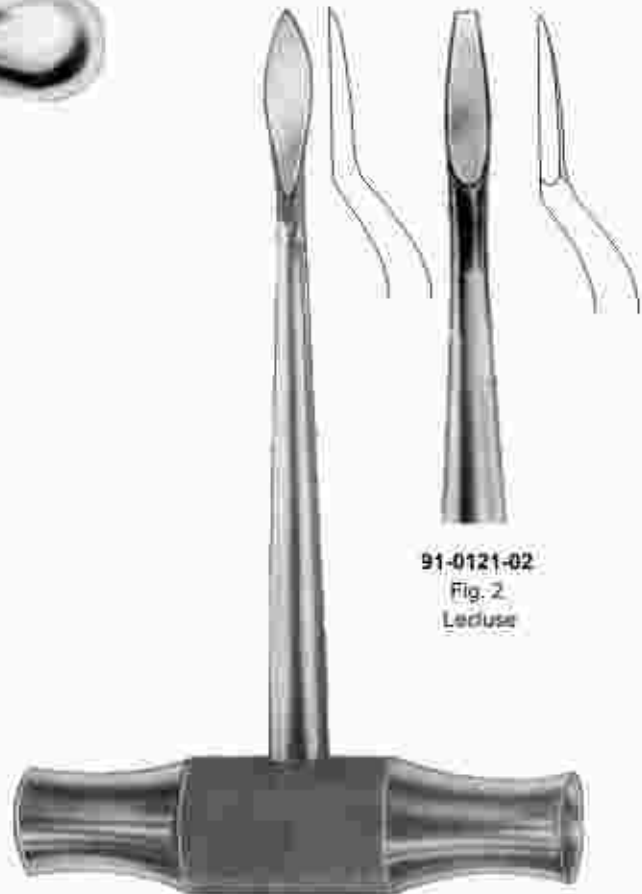

91-0121-01
Fig. 1
Lecluse



91-0121-02
Fig. 2
Lecluse

Root Elevators

ELMED INSTRUMENTS



91-0122-01
Fig. MD1
Mead



91-0120-02
Fig. MD2
Mead



91-0120-03
Fig. MD3
Mead



91-0120-04
Fig. MD4
Mead



91-0122-05
Fig. MD-5A
Mead



91-0122-06
Fig. MD-6A
Mead



91-0122-07
Fig. MD-7A
Mead



91-0122-08
Fig. MD-8A
Mead



91-0122-09
Fig. MD-9A
Mead



91-0122-10
Fig. MD-10A
Mead



91-0122-11
Fig. MD-10A
Mead

Root Elevators

ELMED INSTRUMENTS

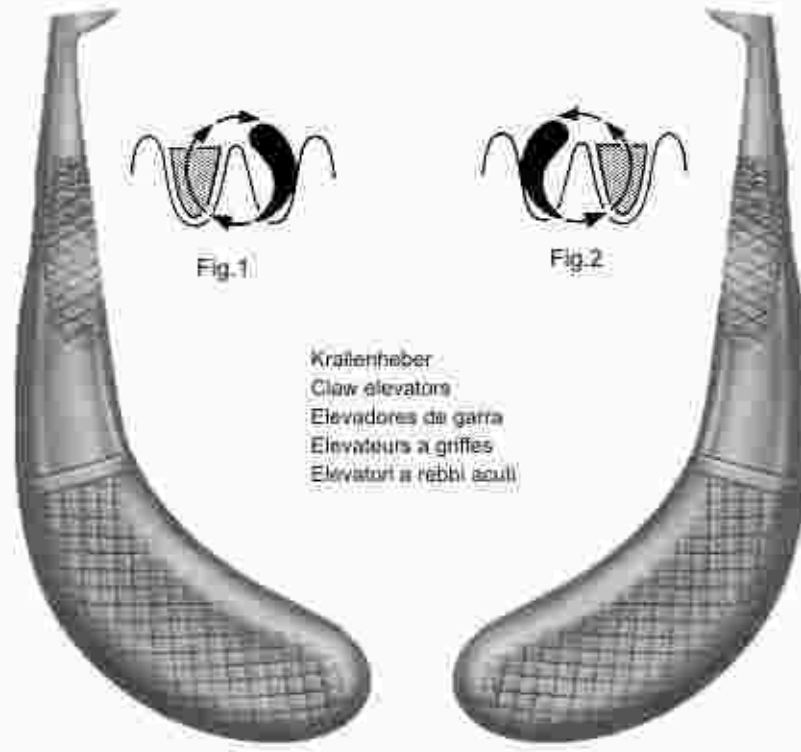

Krallenheber
Claw elevators
Elevadores de garra
Elevateurs a griffes
Elevatori a rebbi acuti

91-0122A-01
Krallenheber

91-0122A-02
Krallenheber



Krallenheber
Claw elevators
Elevadores de garra
Elevateurs a griffes
Elevatori a rebbi acuti

91-0122B-01
Septum Lancets

91-0122B-02
Septum Lancets

Root Elevators

ELMED

INSTRUMENTS



91-0122C-02
Fig.2
4 mm
Bernard

91-0122C-03
Fig.3L
4 mm
Bernard

91-0122C-04
Fig.4R
4 mm
Bernard



91-0122C-01
Fig.1
4 mm
Bernard

2.5 mm



91-0122D-01
Fig.1
Lindo-Levin

3.5 mm



91-0122D-02
Fig.2
Lindo-Levin

4.5 mm



91-0122D-03
Fig.3
Lindo-Levin

Root Elevators

ELMED INSTRUMENTS



91-0122E-03
4 mm
Lindo-Levin

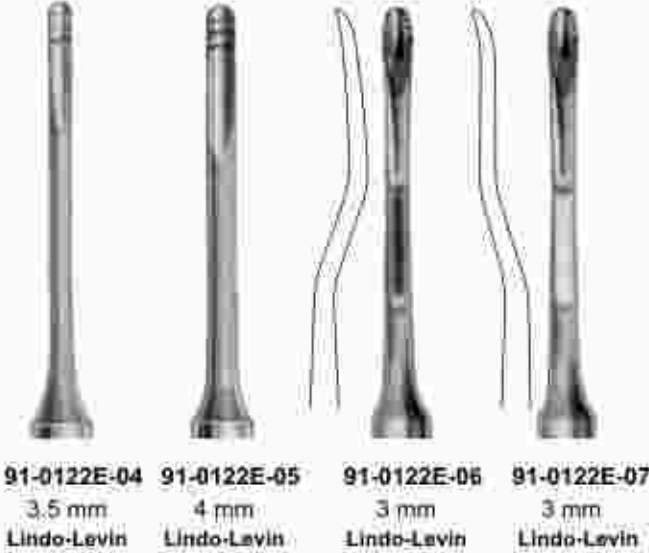

91-0122E-04 91-0122E-05 91-0122E-06 91-0122E-07
3.5 mm 4 mm 3 mm 3 mm
Lindo-Levin Lindo-Levin Lindo-Levin Lindo-Levin



Kopp



91-0122F-01
Fig.1
Kopp



91-0122F-02
Fig.2
Kopp



91-0122F-03
Fig.3
Kopp



91-0122F-04
Fig.4
Kopp



91-0122F-05
Fig.5
Kopp



91-0122F-06
Fig.6
Kopp

Root Elevators

ELMED INSTRUMENTS



91-0122G-10
Fig.1
Kopp



91-0122G-11
Fig.2
Kopp



91-0122G-12
Fig.3
Kopp



91-0122G-13
Fig.4
Kopp



Kopp



91-0122H-01
Fig.1
Schlemmer



91-0122H-02
Fig.2
Schlemmer

Root Elevators

ELMED INSTRUMENTS

1.8 mm



91-0122J-01
Fig. 1
Heidbrink



91-0122J-02
Fig. 2
Heidbrink



91-0122J-03
Fig. 3
Heidbrink



Heidbrink



91-0122K-12
1.2 mm
Heidbrink



91-0122K-15
1.5 mm
Heidbrink



91-0122K-18
1.8 mm
Heidbrink



91-0122K-25
2.5 mm
Heidbrink

Root Elevators

ELMED

INSTRUMENTS



Pott

91-0122L-01
Fig. 1
Pott



91-0122L-02
Fig. 2
Pott



91-0122M-01
Fig. 1

91-0122M-02
Fig. 2



91-0122M-03
Fig. 3



Root Elevators

ELMED INSTRUMENTS



91-0122N-01
Fig. 1
Chompret



91-0122N-02
Fig. 2
Chompret



91-0122N-03
Fig. 3
Chompret



91-0122N-04
Fig. 4
Chompret



91-0123-02
Fig. 2
Heidbrink



91-0123-03
Fig. 3
Heidbrink



90-0123-04
Fig. 1
Warwick-James



90-0123-05
Fig. 2
Warwick-James



90-0123-06
Fig. 3
Warwick-James



91-0123-01
Fig. 1
Heidbrink

Cotton and Dressing Plier

ELMED INSTRUMENTS



91-0124-01
15 cm
London-College



91-0124-02
15 cm
London-College



91-0124-03
15 cm
London-College



91-0124-04
15 cm
London-College



91-0124-05
15 cm
London-College



91-0124-06
15 cm
London-College



91-0124-07
15 cm
London-College



91-0124-08
15 cm
London-College



91-0125-03
15 cm
London-College



91-0125-05
15 cm
London-College

Cotton and Dressing Plier

ELMED
INSTRUMENTS

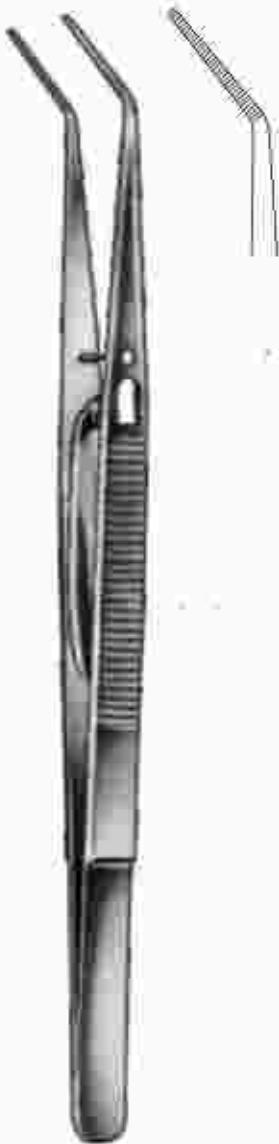

91-0126-01
15 cm
London-College
with lock



91-0126-02
15 cm
London-College
with lock



91-0126-03
15 cm
London-College
with lock



91-0126-04
15 cm
London-College
with lock



91-0126-05
15 cm
London-College
with lock



91-0126-06
15 cm
London-College
with lock



91-0126-07
15 cm
London-College
with lock



91-0126-08
15 cm
London-College
with lock

Cotton and Dressing Pliers

ELMED INSTRUMENTS



Meriam
16 cm

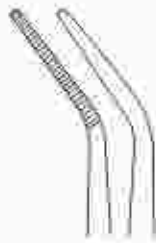

91-0127-01
Fig. 1
16 cm
Meriam



91-0127-02
Fig. 2
16 cm
Meriam



91-0127-03
Fig. 3
16 cm
Meriam



91-0127-04
Fig. 4
16 cm
Meriam



91-0127-07
Fig. 7
16 cm
Meriam



91-0127-08
Fig. 8
16 cm
Meriam

91-0127-05
Fig. 5
16 cm
Meriam

91-0127-06
Fig. 6
16 cm
Meriam



Meriam
15 cm



91-0128-01
Fig. 1
15 cm
Meriam



91-0128-02
Fig. 2
15 cm
Meriam

91-0128-03
Fig. 3
15 cm
Meriam

91-0128-05
Fig. 5
15 cm
Meriam

91-0128-06
Fig. 6
15 cm
Meriam

Cotton and Dressing Pliers

ELMED INSTRUMENTS



Fiagg
16 cm



91-0129-01
Fig. 1
16 cm
Serrated



Fiagg
16 cm



91-0129-02
Fig. 2
16 cm
Smooth



91-0129-03
Fig. 3
16 cm
Serrated



91-0129-04
Fig. 4
16 cm
Smooth



Landgraf
15 cm



91-0129-05
Fig. 3
15 cm



91-0129-06
Fig. 4
15 cm



Perry
13 cm



91-0129-07
Serrated
13 cm



Perry
13 cm



91-0129-08
Smooth
13 cm



Perry
13 cm



91-0129-09
Smooth
13 cm

Scalers

ELMED INSTRUMENTS



Standard
18.5 cm / 6"



91-0130-01
Fig. 1



91-0130-02
Fig. 2



91-0130-03
Fig. 3



91-0130-04
Fig. 4



91-0130-05
Fig. 5



91-0130-06
Fig. 7



91-0130-07
Fig. 9



91-0130-08
Fig. 12



91-0130-09
Fig. 14



91-0130-10
Fig. 25



91-0130-11
Fig. 28

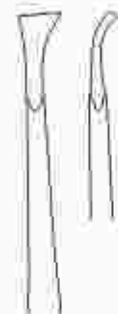

91-0130-12
Fig. 32



91-0130-13
Fig. 33



91-0130-14
Fig. 34



91-0130-15
Fig. 33-1/2



91-0130-16
Fig. 34-1/2

Scalers

ELMED INSTRUMENTS



Derby-Perry



91-0131-01
Fig. 1



91-0131-04
Fig. 4



91-0131-06
Fig. 6



91-0131-05
Fig. 5



91-0131-11
Fig. 11



91-0132-01
Fig. 1
White



91-0132-02
Fig. 2
White



91-0132-03
Fig. 3
White



91-0132-04
Fig. 4
White 12 B



91-0133-01
Fig. 1
Jquette



91-0133-02
Fig. 2
Jquette



91-0133-03
Fig. 3
Jquette

Scalers

ELMED INSTRUMENTS



91-0134-01
Fig. 1
Mc Call



91-0134-05
Fig. 5
Mc Call



91-0134-06
Fig. 6
Mc Call



91-0134-07
Fig. 7
Mc Call



91-0134-08
Fig. 8
Mc Call



91-0134-09
Fig. 9
Mc Call



91-0134-10
Fig. 10
Mc Call



91-0136-01
Fig. 1
Cumine



91-0135-01
Fig. 1
Abbott



91-0135-02
Fig. 2
Abbott



91-0135-03
Fig. 3
Abbott



91-0135-04
Fig. 4
Abbott



91-0137-01
Fig. 1
Mitchell



91-0138-01
Fig. 1
Guenther



91-0139-33/34
Fig. 33/34

Scalers

ELMED INSTRUMENTS



91-0140-02
Fig. 2L/2R
Columbia



91-0140-04
Fig. 4L/4R
Columbia



91-0140-13/14
Fig. 13/14
Columbia



91-0141-02
Fig. 13
Younger-Good



91-0141-03
Fig. 14
Younger-Good



91-0141-04
Fig. 15
Younger-Good



91-0141-01
Fig. 7/8
Younger-Good

Periodontal Instruments

ELMED
INSTRUMENTS



91-0143-01
Fig. 11/12
Mc Call



91-0143-02
Fig. 11A/12A
Mc Call



91-0143-03
Fig. 13/14
Mc Call



91-0143-04
Fig. 13S/14S
Mc Call



91-0143-05
Fig. 17S/18S
Mc Call



91-0143-05
Fig. 19/20
Mc Call

Scalers

ELMED INSTRUMENTS



91-0144-05
Fig. 5
Hygienist
15 cm



91-0144-06
Fig. 6
Hygienist



91-0144-07
Fig. 7
Hygienist



91-0144-08
Fig. 8
Hygienist



91-0144-09
Fig. 9
Hygienist



91-0145-01
Fig. 1
Black



91-0145-02
Fig. 2
Black



91-0145-03
Fig. 3
Black



91-0145-04
Fig. 4
Black



91-0145-05
Fig. 5
Black



91-0145-06
Fig. 6
Black



91-0145-07
Fig. 7
Black



91-0145-08
Fig. 8
Black



91-0145-09
Fig. 9
Black



91-0145-10
Fig. 10
Black



91-0145-11
Fig. 11
Black



91-0145-12
Fig. 12
Black



91-0146-01
Globe



91-0147-01
Fig. 1
Muehmann



91-0147-02
Fig. 5
Muehmann



91-0147-03
Fig. 6
Muehmann



91-0148-01
Fig. 1



91-0148-02
Fig. 2



91-0149-01
Fig. 1



91-0149-02
Fig. 2



91-0149-03
Fig. 3



91-0149-04
Fig. 4



Gingivectomy Knife

91-0150-01
Fig.
Round Handle



91-0151-01



91-0152-01
Fig.7
Gingivectomy Knife



91-0152-02
Fig.8
Gingivectomy Knife



91-0152-03
Fig.9
Gingivectomy Knife

Periodontia Currettes

ELMED
INSTRUMENTS

GRACEY CURETTES



91-0153-01
Fig.1/2



91-0153-02
Fig.3/4



91-0153-03
Fig.5/6



91-0153-04
Fig.7/8



91-0153-05
Fig.9/10



91-0153-06
Fig.11/12



91-0153-07
Fig.13/14

GRACEY CURETTES



91-0153-08
Fig. 1/2



91-0153-09
Fig. 3/4



91-0153-10
Fig. 5/6



91-0153-11
Fig. 7/8



91-0153-12
Fig. 9/10



91-0153-12
Fig. 11/12



91-0153-12
Fig. 13/14

Kirkland Gingivectomy Knife



91-0154-01
Fig. 15
Kirkland

91-0154-02
Fig. 16
Kirkland



91-0154-03
Fig. 15/16
Kirkland

Scaler Point Interchangeable

ELMED
INSTRUMENTS



91-0155-0H
Fig. 15/16
Morse



Form A
Morse



91-0155-01
Fig. 0
Morse



91-0155-02
Fig. 1
Morse



91-0155-03
Fig. 6
Morse



91-0155-04
Fig. 7
Morse



91-0155-05
Fig. 8
Morse



91-0155-06
Fig. 9
Morse



91-0155-07
91-0155-08
Fig. CPG 11.5 WHO



91-0155-09
91-0155-10
Fig. CPG 12



91-0155-11
91-0155-12
Fig. CP 21 UNC



91-0155-13
91-0155-14
Fig. GPN 22

Periodontia Instruments

ELMED
INSTRUMENTS



91-0156-01
Fig. 2
Whiteside



91-0156-02
Fig. 11
Whiteside

91-0156-03
Fig. 12
Whiteside

Periodontia Instrument Set



91-0157-01
Periodontia Set Complete

Gingivectomy Knives

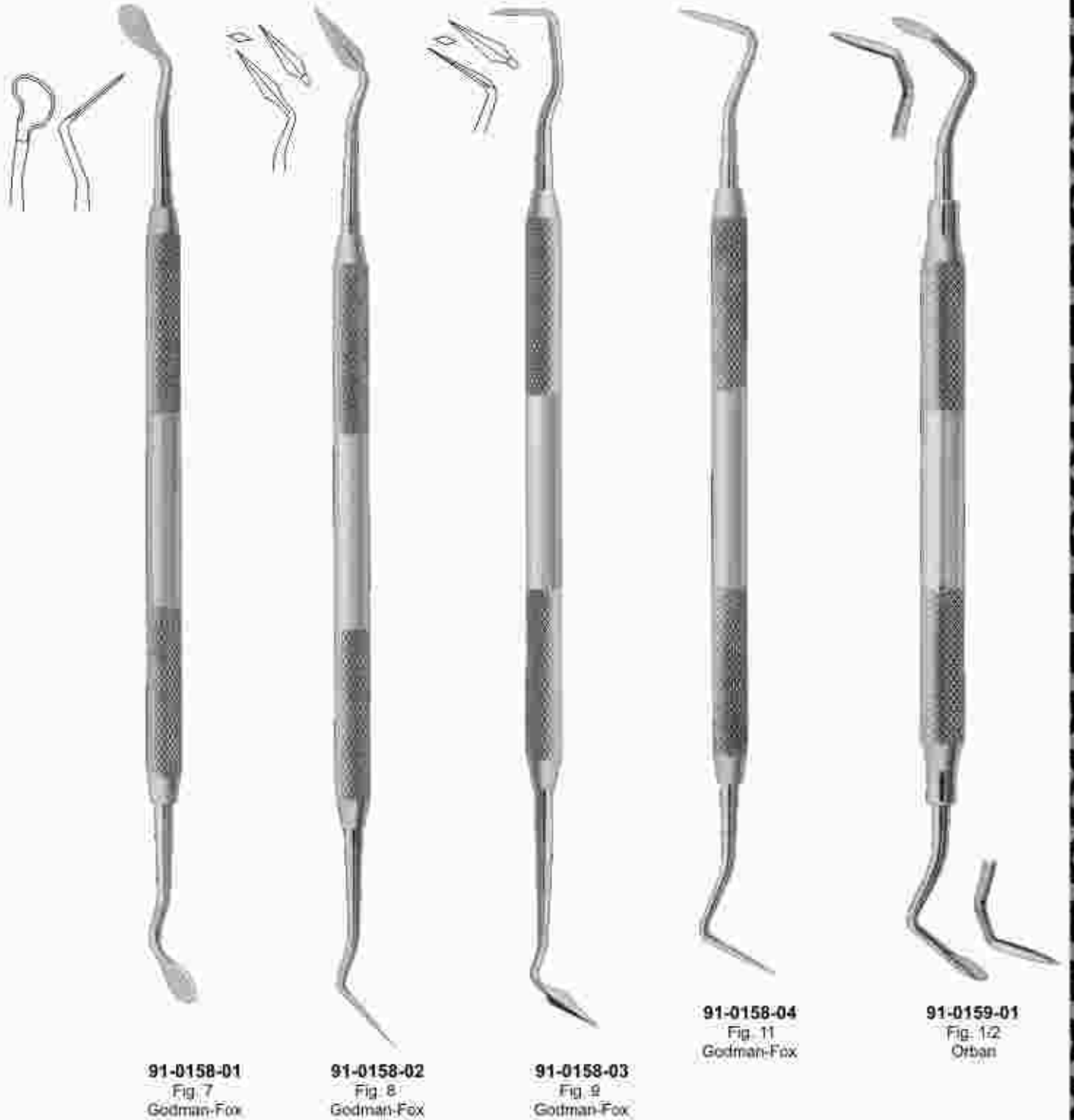

Gingivectomy Knives



91-0159-02
Fig. 1
Orban

91-0159-03
Fig. 2
Orban

Pocket Markers

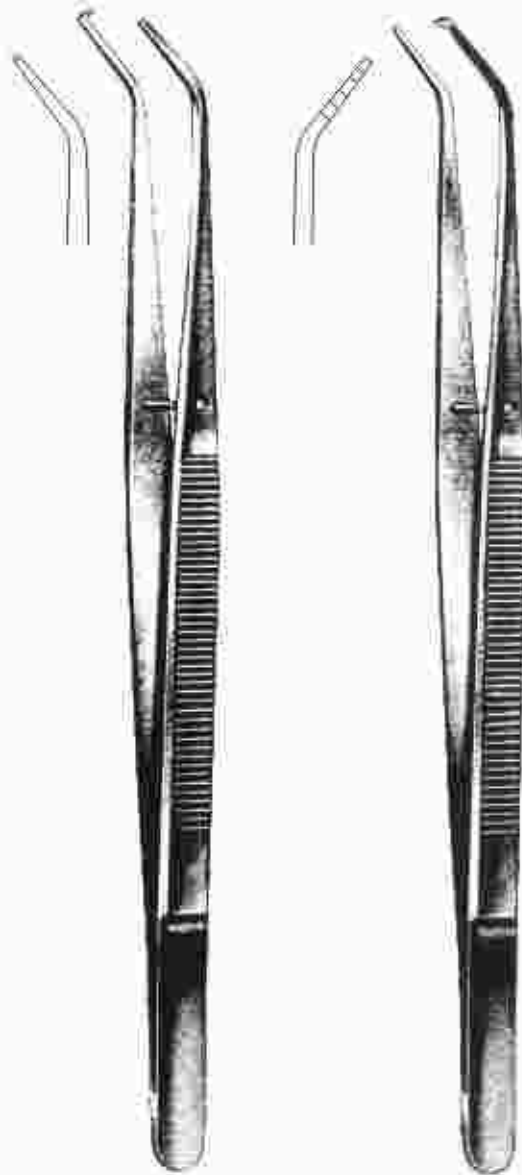

91-0160-01
Fig. 1
Crane Kaplan

Periodontia Pocket Probe
& Calibrated Probes

ELMED
INSTRUMENTS



91-0161-01
Fig. 1
Williams

91-0161-02
Fig. 2
Merrit A

91-0161-03
Fig. 3
Merrit B

91-0161-04
Fig. 4
Goldman Fox
Flat

91-0161-05
Fig. 5
University of
Michigan

New making process.
Laser system marking.
No more post peeling off
Permanent marking.
Anglers, too depth marking.
Maximum resistance against
bending.



91-0162-06
Fig. CP-C

91-0162-07
Fig. CP-11

91-0162-08
Fig. CP-12

Periodontia Probes

ELMED INSTRUMENTS



91-0163-01
Fig. 23.



91-0164-01
Krenn

91-0164-02
Krenn



16 cm / 6 3/4"



91-0165-01
Fig. 8



91-0165-02
Fig. 10



91-0165-03
Fig. 11



91-0165-04
Fig. 9



91-0165-05
Fig. W



91-0165-06
Fig. CGF 11.5 WHO



91-0165-07
Merrill A



91-0165-08
Merrill E

Periodontia Probes

ELMED INSTRUMENTS



91-0165-09
Willama-Goldman Fox



91-0165-10
Fig. CP 11/23



91-0165-11
Fig. CP 12/23



91-0165-12
Fig. GF/3



91-0165-13
Fig. UM/3



91-0165-14
Fig. W/3



91-0165-14
Fig. GF/6



91-0165-15
Fig. UM/6



91-0165-16
Fig. W/8



91-0165-20
Fig. GF/17

17.5 cm / 6 3/4"

Enamel Instruments

ELMED INSTRUMENTS



Wite



91-0166-01
Fig.1



91-0166-02
Fig.2



91-0166-03
Fig.3



91-0166-04
Fig.4



91-0166-05
Fig.5



91-0166-07
Fig.7



91-0166-08
Fig.8



91-0166-09
Fig.9



91-0167-01
Fig.1/2
Wedeltaedl.



91-0167-02
Fig.3/4
Wedeltaedl.

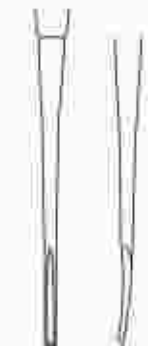

91-0167-03
Fig.10
Black



91-0167-04
Fig.28
Black



91-0167-05
Fig.48
Black



91-0167-06
Fig.50
Black



91-0167-07
Fig.51
Black



91-0167-08
Fig.52
Black



91-0167-09
Fig.53
Black



91-0167-10
Fig.54
Black



91-0167-11
Fig.61
Black



91-0167-12
Fig.62
Black



91-0167-13
Fig.63
Black



91-0167-14
Fig.64
Black



91-0167-15
Fig.65
Black



91-0167-16
Fig.66
Black

Probes and Explorers

ELMED INSTRUMENTS



91-0168-01
Fig.01



91-0168-02
Fig.2



91-0168-03
Fig.3

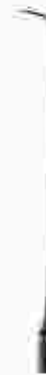

91-0168-04
Fig.5

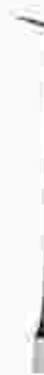

91-0168-05
Fig.6



91-0168-06
Fig.7



91-0168-07
Fig.9



91-0168-08
Fig.10



91-0168-09
Fig.11



91-0168-10
Fig.12



91-0168-11
Fig.13



91-0168-12
Fig.14



91-0168-13
Fig.17



91-0168-14
Fig.18



91-0168-15
Fig.20



91-0168-16
Fig.21



91-0168-17
Fig.22



91-0168-18
Fig.23



91-0168-19
Fig.42



91-0168-20
Fig.43



91-0168-21
Fig.44



91-0168-22
Fig.45

Probes and Explorers

ELMED INSTRUMENTS



91-0169-01
Fig. 1



91-0169-02
Fig. 2



91-0169-03
Fig. 17



91-0169-04
Fig. 23



91-0169-05
Fig. 26



91-0169-06
Fig. 30



91-0169-07
Fig. 32



91-0169-08
Fig. 33



91-0169-09
Fig. 34



91-0169-10
Fig. 42



91-0169-11
Fig. 43



91-0169-12
Fig. 44



91-0169-13
Fig. 45



91-0170-01
Fig. 01



91-0170-02
Fig. 2



91-0170-03
Fig. 17



91-0170-04
Fig. 23



91-0170-04
Fig. 26



91-0170-05
Fig. 30



91-0170-06
Fig. 32



91-0170-07
Fig. 33



91-0170-08
Fig. 34



91-0170-09
Fig. 42



91-0170-10
Fig. 43



91-0170-11
Fig. 44



91-0170-12
Fig. 45

Probes and Explorers

ELMED INSTRUMENTS



91-0171-01
Fig.1



91-0171-02
Fig.2



91-0171-03
Fig.3



91-0171-04
Fig.4



91-0171-05
Fig.5



91-0171-06
Fig.5A



91-0171-07
Fig.6



91-0171-08
Fig.6A



91-0171-09
Fig.7



91-0171-10
Fig.8



91-0171-11
Fig.8A



91-0171-12
Fig.9



91-0172-01
Fig.1



91-0172-02
Fig.2



91-0172-03
Fig.3

Probes and Explorers

ELMED INSTRUMENTS



91-0173-01
Fig.1
Weston



91-0173-02
Fig.2
Weston



91-0174-01
Fig.1
Lange



91-0174-02
Fig.2
Lange



Cross



91-0175-10
Fig.10
Cross



91-0176-02
Fig.2
Zurich



91-0177-17
Fig.17
White



91-0177-23
Fig.23
White

Excavators

ELMED INSTRUMENTS



91-0178-05
Fig. 5
Darby-Parry



91-0178-06 Fig. 8 91-0178-09 Fig. 9 91-0178-10 Fig. 10 91-0178-11 Fig. 11 91-0178-12 Fig. 12 91-0178-13 Fig. 13 91-0178-14 Fig. 14 91-0178-15 Fig. 15 91-0178-16 Fig. 16

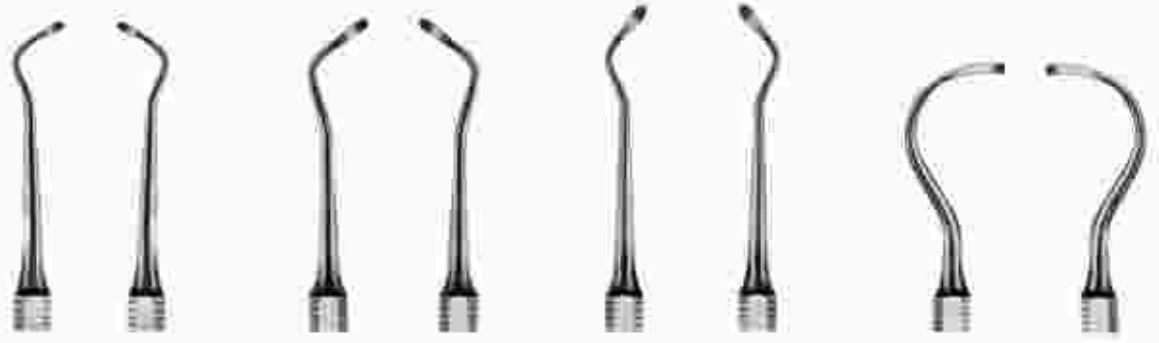

91-0178-17 Fig. 17 91-0178-18 Fig. 18 91-0178-19 Fig. 19 91-0178-20 Fig. 20 91-0178-21 Fig. 21 91-0178-22 Fig. 22 91-0178-23 Fig. 23 91-0178-24 Fig. 24



91-0178-26 Fig. 26 91-0178-27 Fig. 27 91-0178-28 Fig. 28 91-0178-29 Fig. 29 91-0178-30 Fig. 30 91-0178-31 Fig. 31 91-0178-32 Fig. 32 91-0178-33 Fig. 33 91-0178-34 Fig. 34 91-0178-35 Fig. 35

Excavators

ELMED INSTRUMENTS



91-0179-01 Fig.243
Gillet
91-0179-02 Fig.244
Gillet
91-0179-03 Fig.245
Gillet
91-0179-04 Fig.246
Gillet



91-0180-01
Fig.131/132



91-0180-01 Fig.133/134
91-0180-02 Fig.155/156



91-0181-01 Fig.73/74
91-0181-02 Fig.74/111

91-0181-01
Fig.72/73

Root Canal Spreaders



91-0182-01
Fig.1



91-0182-02
Fig.2



91-0182-03
Fig.3



91-0182-04
Fig.4



91-0182-05
Fig.5



91-0182-06
Fig.6



91-0182-07
Fig.7

Endodontic Instruments

ELMED INSTRUMENTS

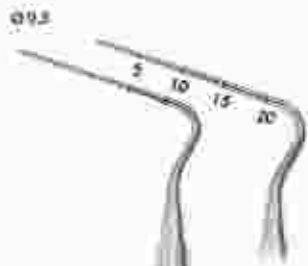

91-0183-01
Fig.1
Vertical condenser

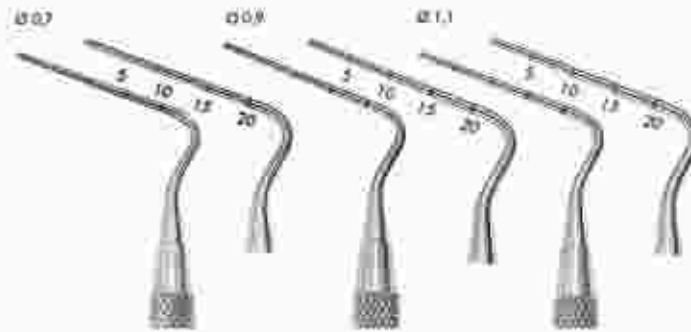

91-0183-02
Fig.2
Vertical condenser

91-0183-03
Fig.3
Vertical condenser

91-0183-04
Fig.4
Vertical condenser



91-0184-01
Fig.1
Luxe



91-0184-02
Fig.2
Luxe



91-0184-03
Fig.3
Luxe



91-0184-04
Fig.4
Luxe

Nerve Instruments & Amalgum Condensers

ELMED INSTRUMENTS



Thuerriegel



91-0185-02
Fig.2
Thuerriegel



91-0185-03
Fig.3
Thuerriegel



91-0185-04
Fig.4
Thuerriegel



91-0185-08
Fig.8
Thuerriegel



91-0185-09
Fig.9
Thuerriegel



91-0185-10
Fig.10
Thuerriegel



Black



91-0186-00
Fig.0
Black



91-0186-01
Fig.1
Black



91-0186-02
Fig.2
Black



91-0186-03
Fig.3
Black



91-0186-04
Fig.4
Black



91-0186-05
Fig.5
Black



91-0186-06
Fig.6
Black



91-0186-07
Fig.7
Black

Amalgam Condensers

ELMED INSTRUMENTS

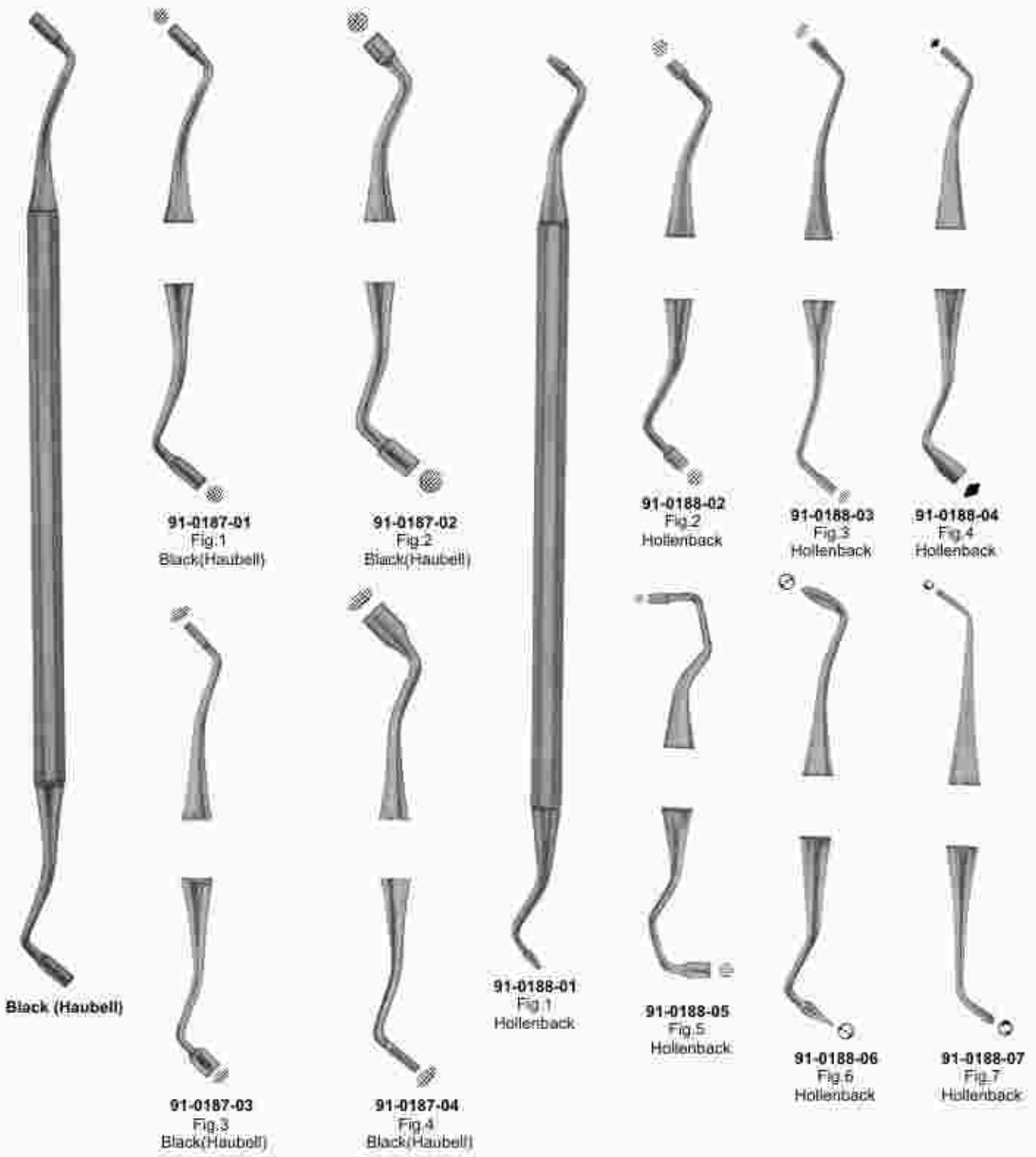

91-0187-01
Fig.1
Black(Haubell)

91-0187-02
Fig.2
Black(Haubell)

91-0188-02
Fig.2
Hollenback

91-0188-03
Fig.3
Hollenback

91-0188-04
Fig.4
Hollenback

Black (Haubell)

91-0188-01
Fig.1
Hollenback

91-0188-05
Fig.5
Hollenback

91-0188-06
Fig.6
Hollenback

91-0188-07
Fig.7
Hollenback

91-0187-03
Fig.3
Black(Haubell)

91-0187-04
Fig.4
Black(Haubell)

Amalgam Condensers

ELMED INSTRUMENTS

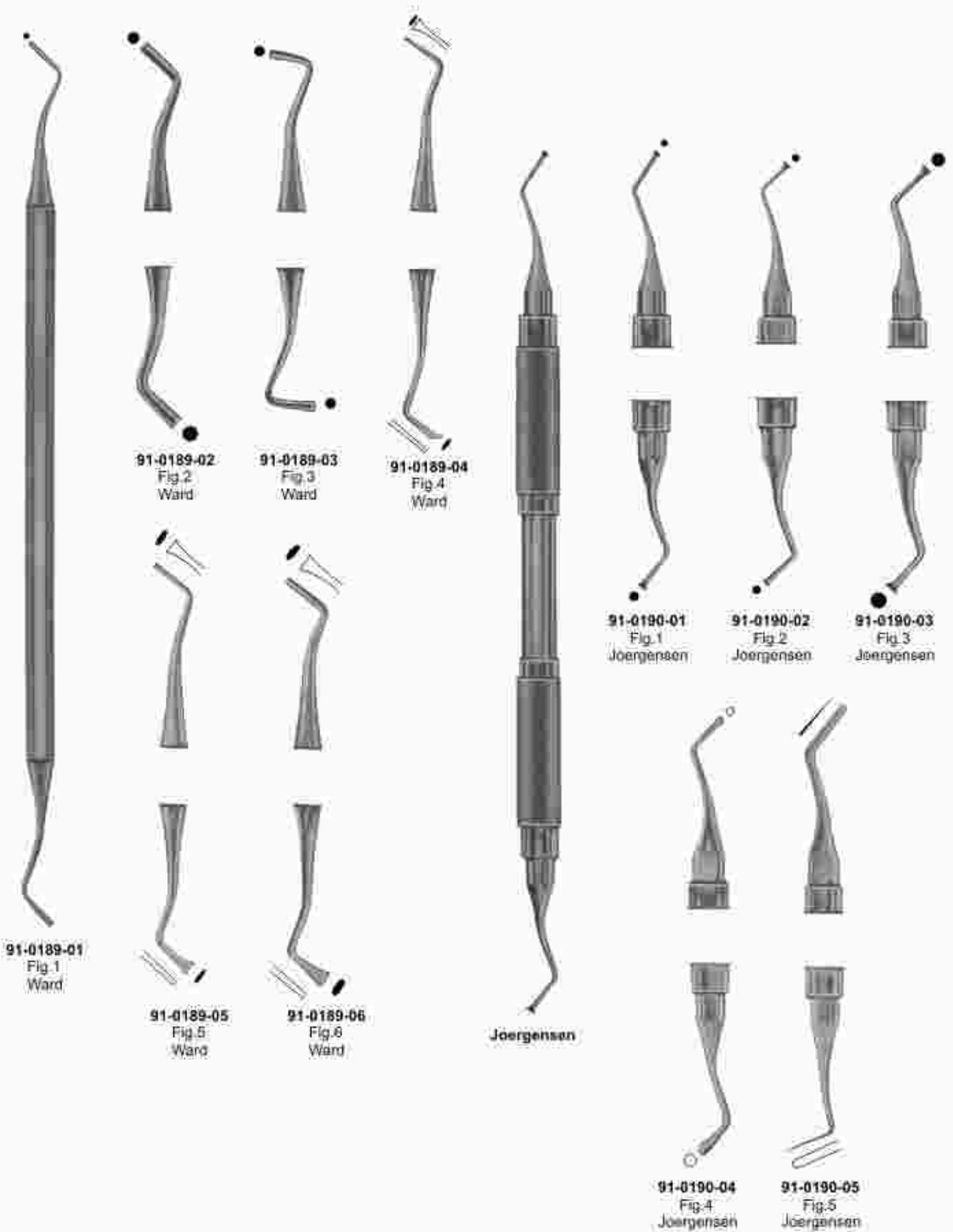

Filling Instruments

ELMED INSTRUMENTS



91-0191-00



91-0191-01
Fig.1



91-0191-02
Fig.2



91-0191-03
Fig.6



91-0192-01
Fig.2
Mortensen



91-0192-02
Fig.21
Mortensen



91-0192-02
Fig.21B
Mortensen



91-0191-04
Fig.7



91-0191-05
Fig.8



91-0191-06
Fig.8A



Ladmore



91-0193-01
Fig.1
Ladmore



91-0193-02
Fig.2
Ladmore



91-0193-03
Fig.3
Ladmore



Filling Instruments

ELMED INSTRUMENTS

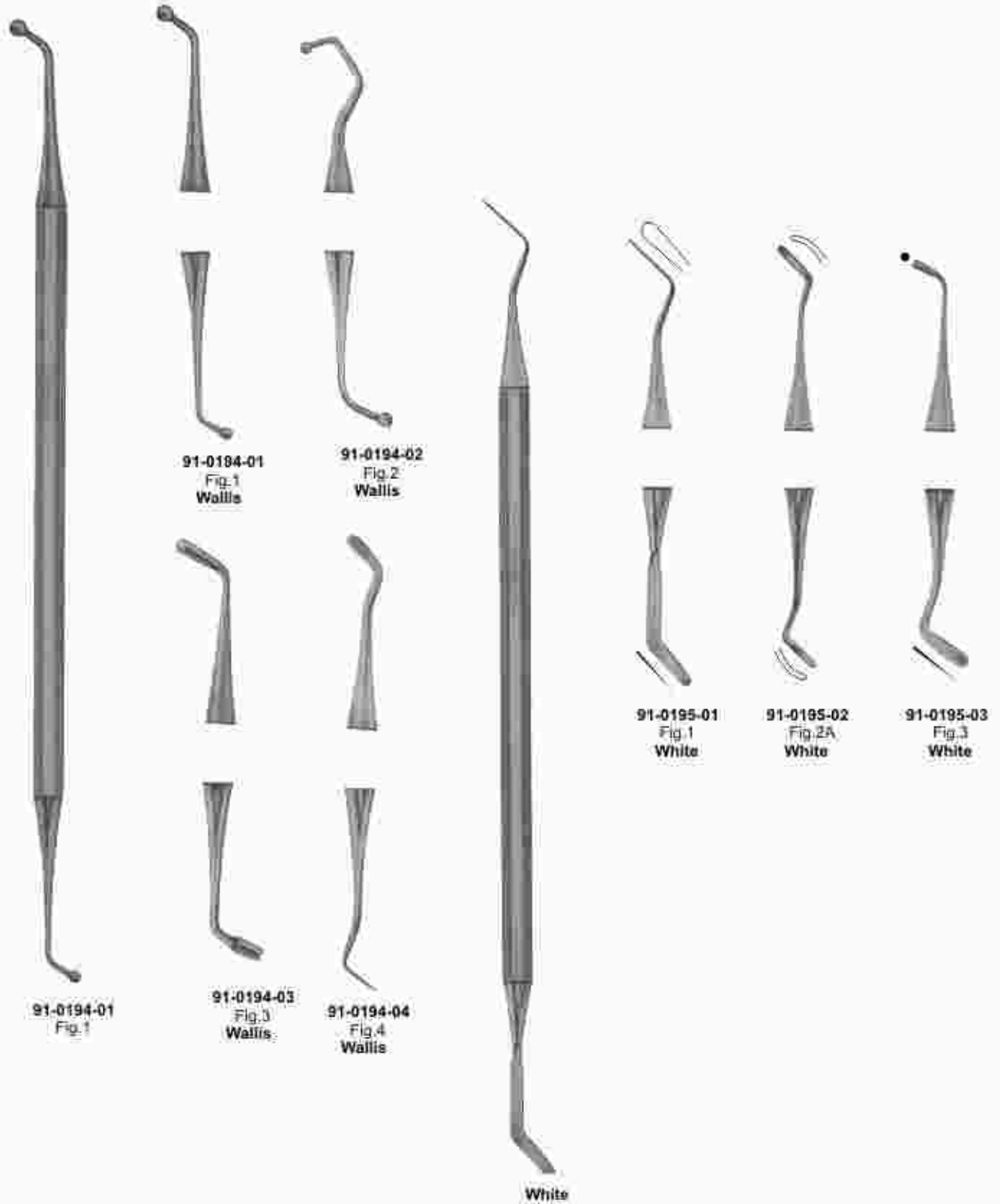

Filling Instruments

ELMED INSTRUMENTS

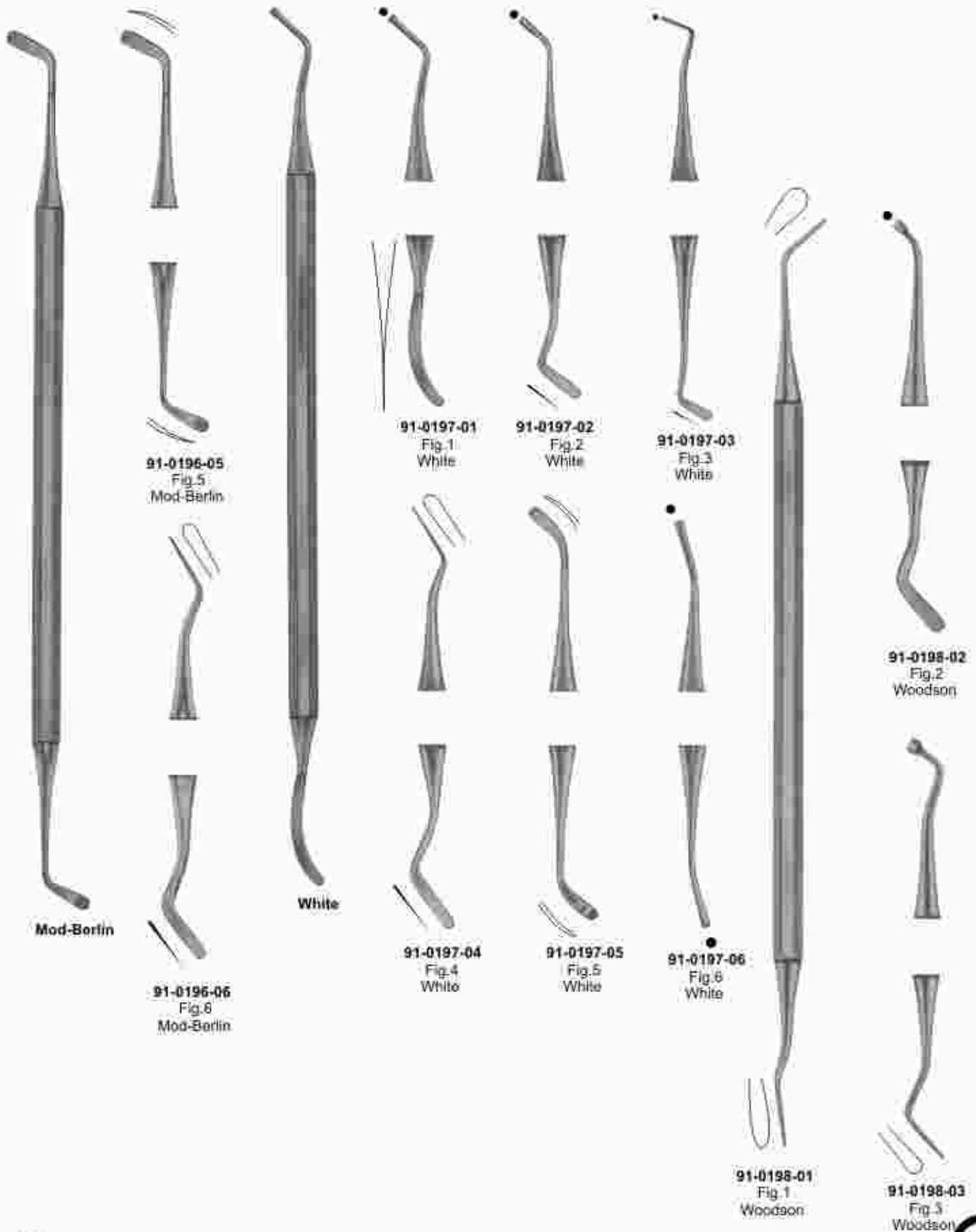

Filling Instruments

ELMED INSTRUMENTS

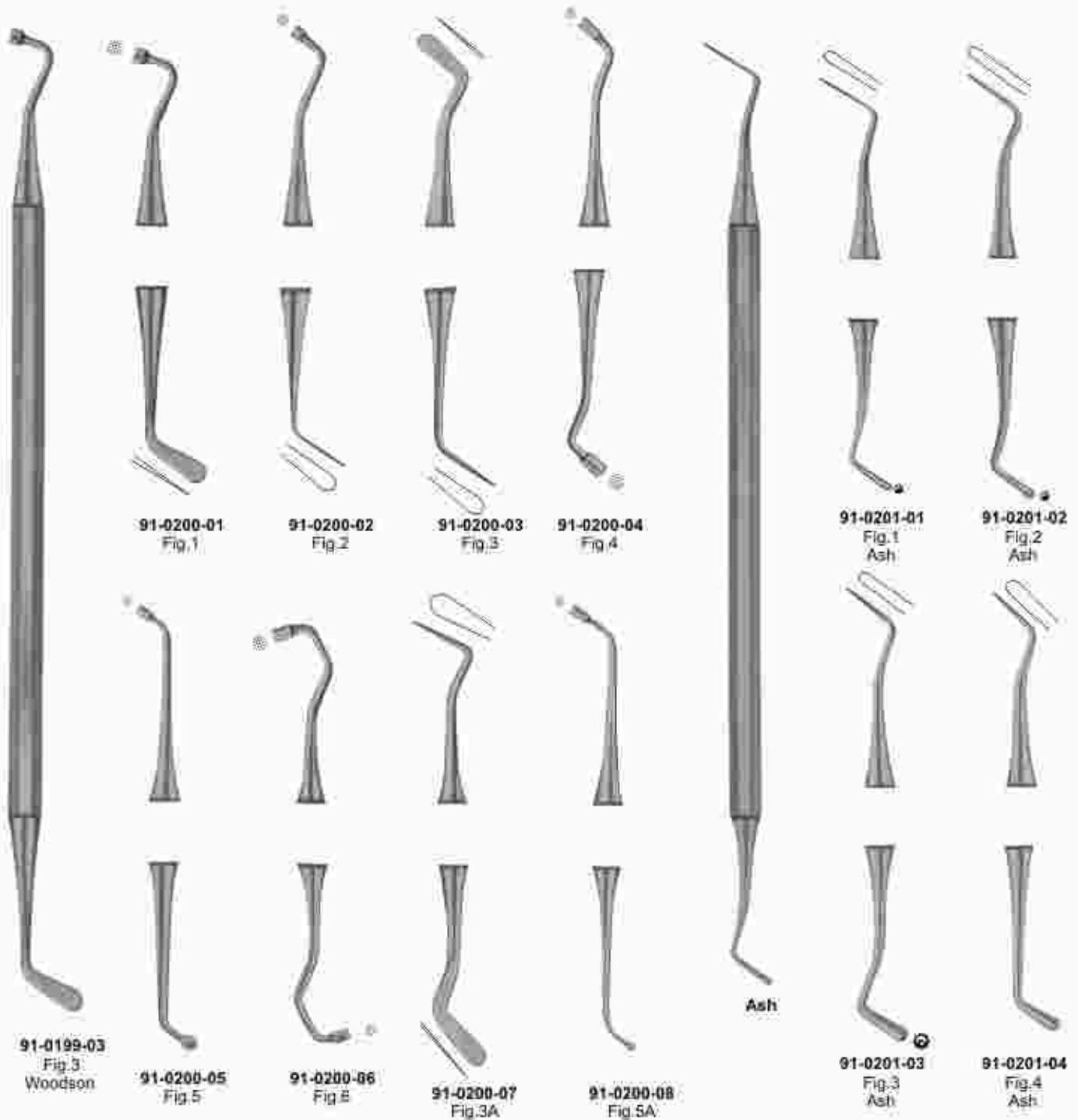

Filling Instruments

ELMED INSTRUMENTS



91-0202-00
Elliott

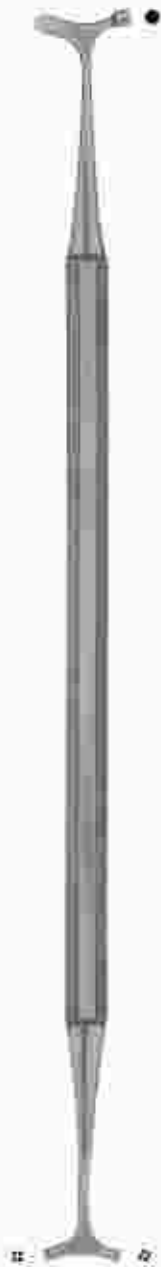

91-0203-00
Bennett



Williams



91-0204-01
Fig.1
Williams



91-0204-02
Fig.2
Williams



91-0204-03
Fig.3
Williams



91-0204-04
Fig.4
Williams



91-0204-05
Fig.5
Williams



91-0204-06
Fig.6
Williams



91-0204-07
Fig.1A
Williams

Filling Instruments

ELMED INSTRUMENTS

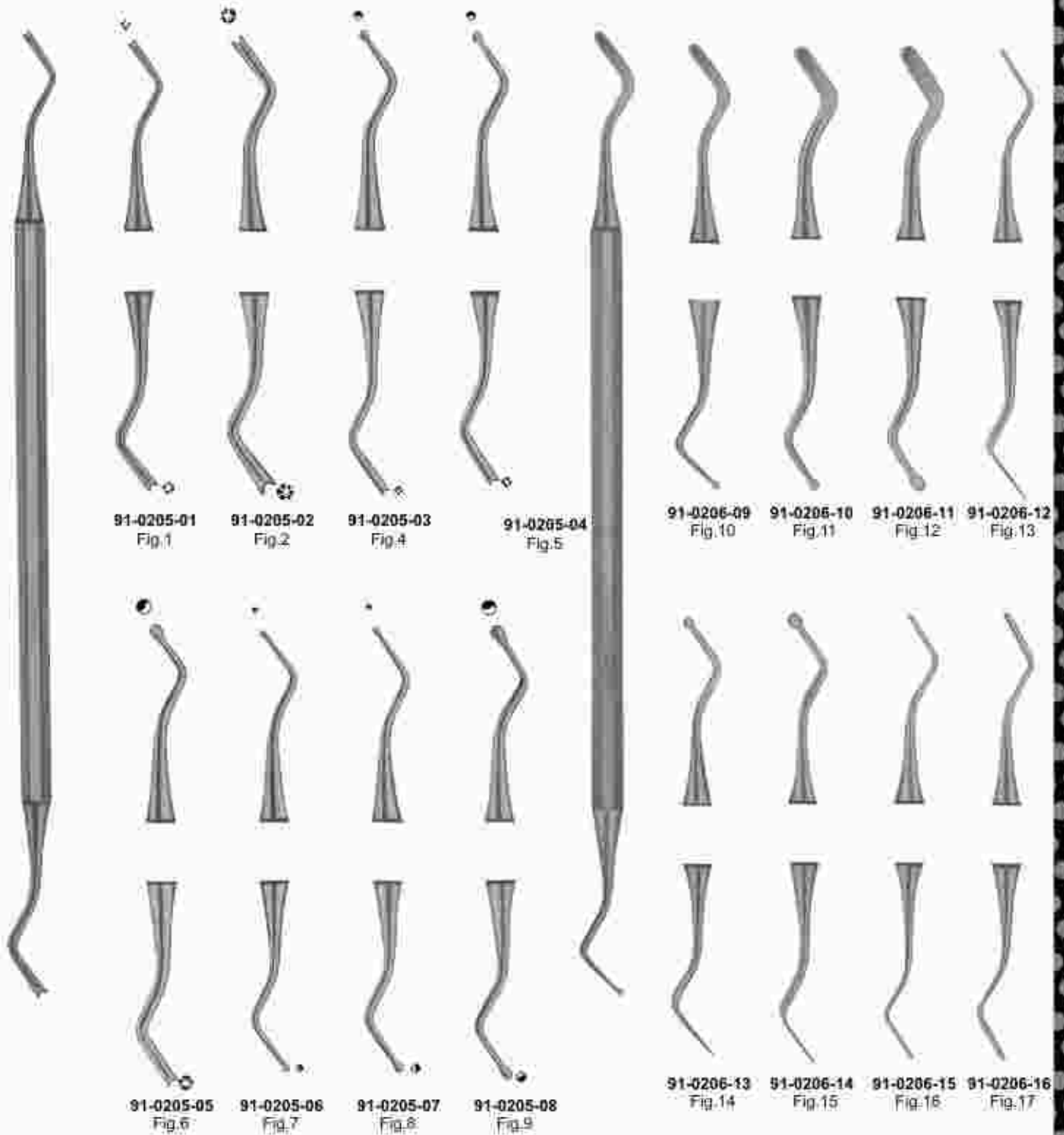

Filling Instruments

ELMED
INSTRUMENTS



91-0207-01
Fig. 28



91-0207-02
Fig. 31



91-0207-03
Fig. 34



91-0207-04
Fig. 35

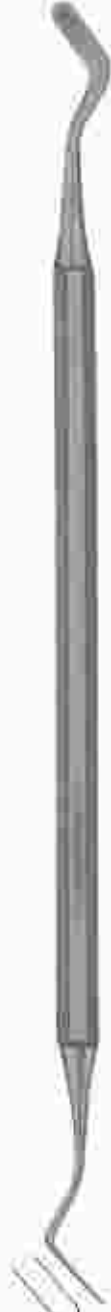

91-0207-05
Fig. 36

Filling Instruments

ELMED INSTRUMENTS

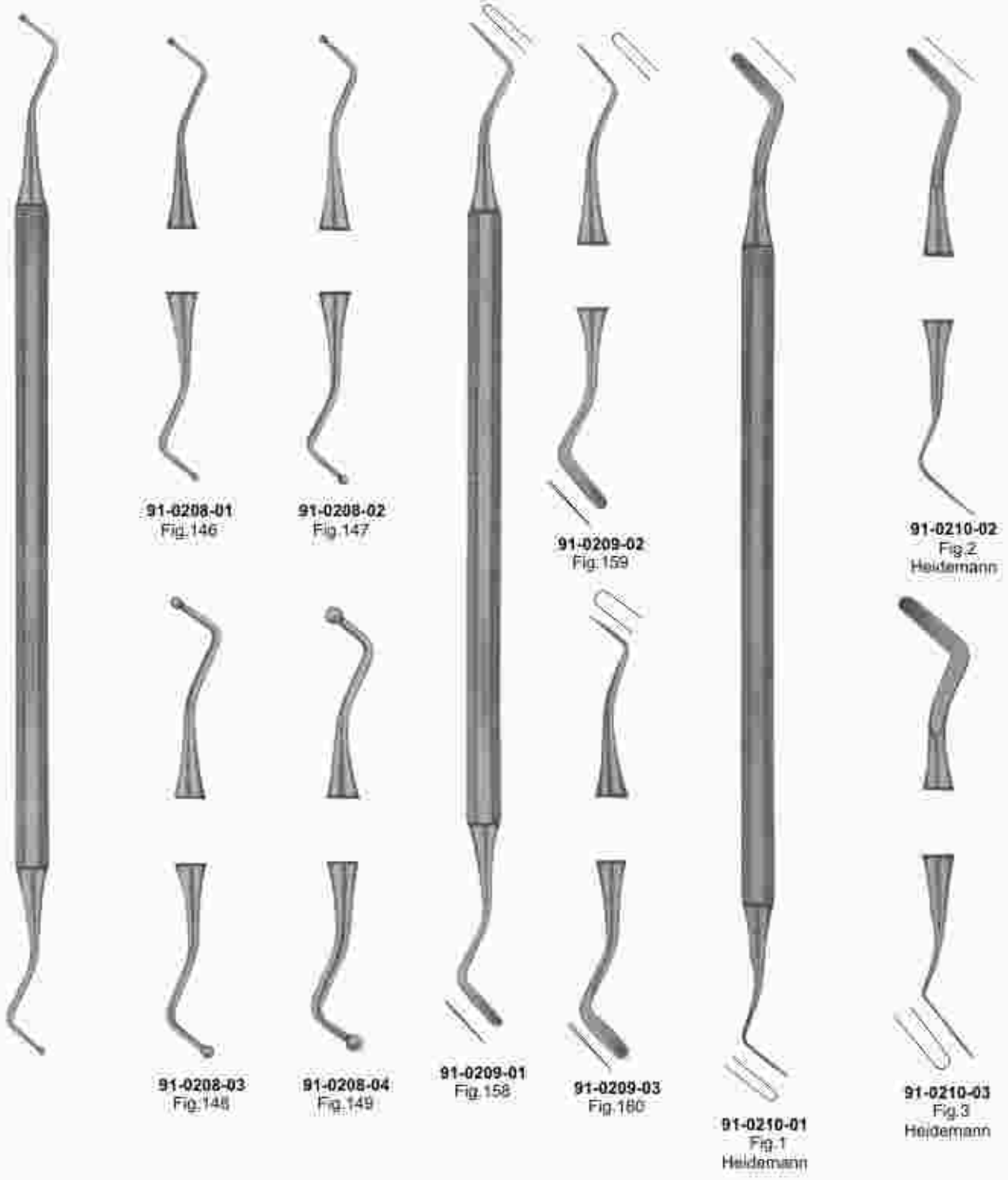

Filling Instruments

ELMED INSTRUMENTS



91-0211-01
Fig.1



91-0211-01
Fig.1



91-0211-02
Fig.2



91-0211-02
Fig.2



91-0211-01
Fig.1



91-0211-03
Fig.3



91-0211-02
Fig.2



91-0212-01
Fig.1



91-0212-01
Fig.1



91-0212-02
Fig.2



91-0212-02
Fig.2



91-0212-03
Fig.3



91-0212-03
Fig.3

Amalgam Carvers

ELMED INSTRUMENTS

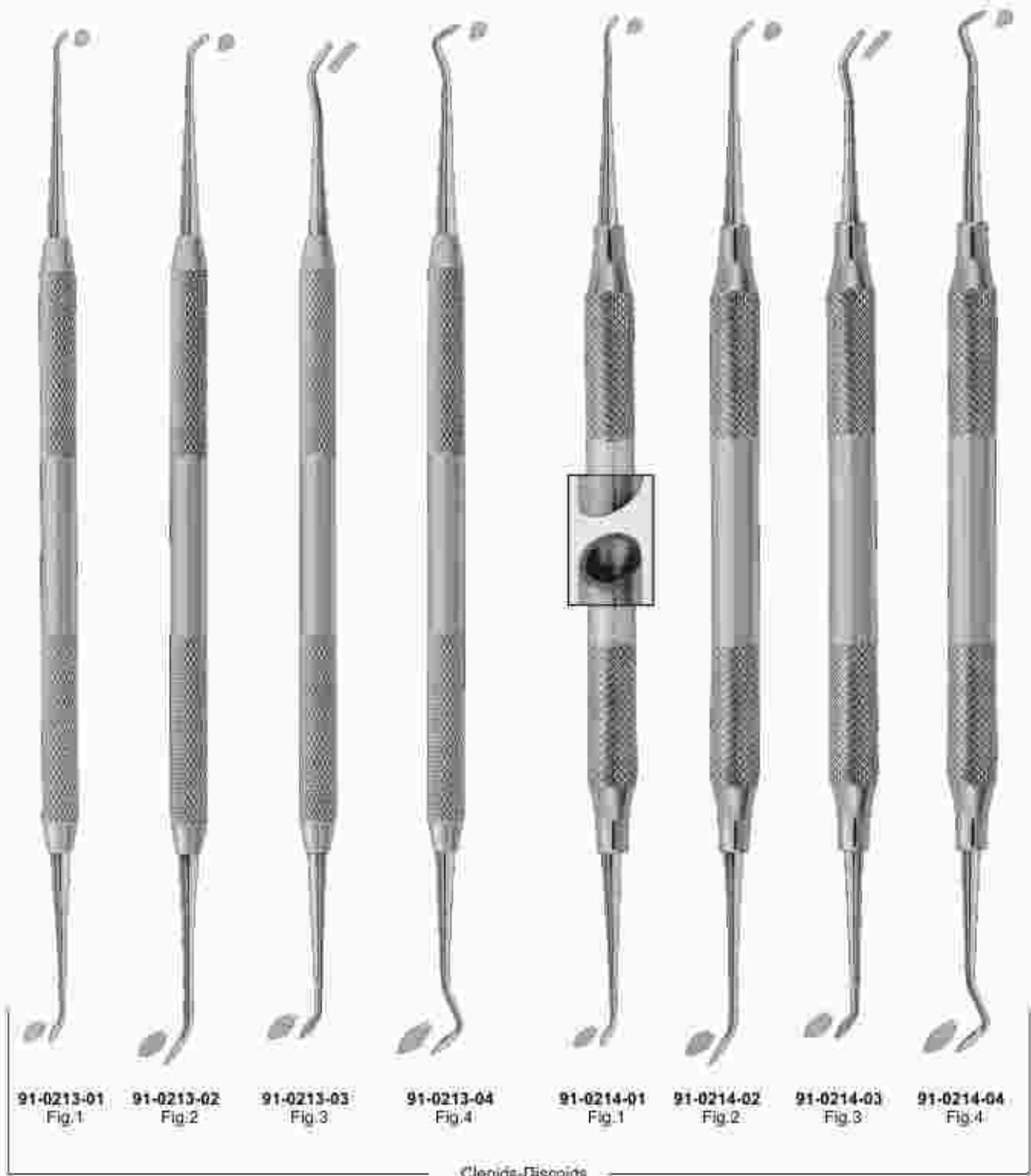

Amalgam Carvers

ELMED INSTRUMENTS



91-0216-01
Fig.1
Black/53-54

91-0216-02
Fig.2
Black/51-52

91-0217-01
Fig.1/2
Wedekstaet

91-0217-02
Fig.3/4
Wedekstaet

91-0217-03
Fig.5/6
Wedekstaet

Gingival margin trimmers

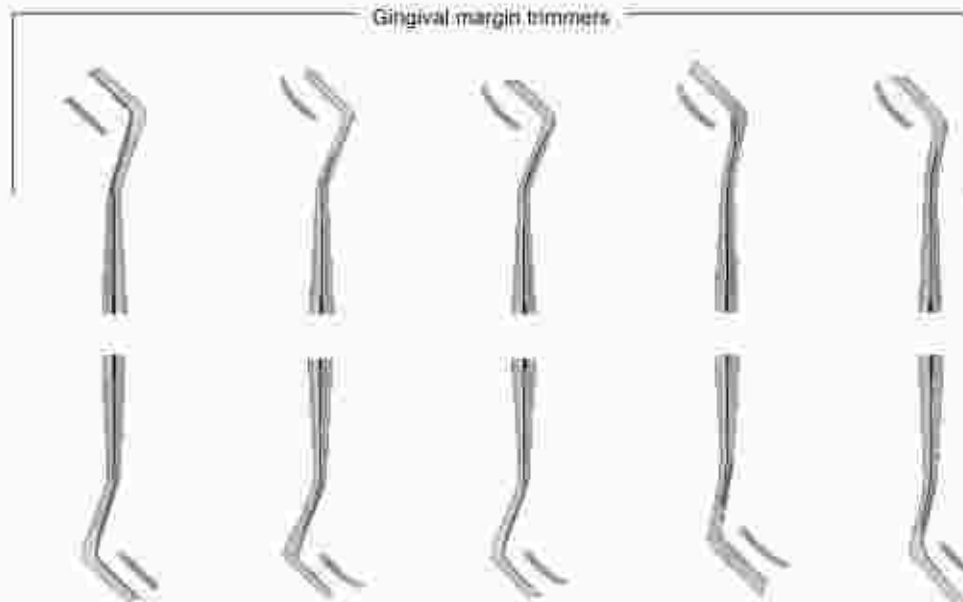

91-0215-01
Fig.1
Black/26
Distal

91-0215-02
Black/27
Mesial

91-0215-03
Black/28
Distal

91-0215-04
Black/29
Mesial

91-0218-01
Black/77-78
Distal

91-0218-02
Black/79-80
Mesial

Polishing & Carving Instruments

ELMED
INSTRUMENTS



White



91-0219-01
Fig.28
White



91-0219-02
Fig.29
White



91-0219-03
Fig.30
White



91-0219-04
Fig.32
White



91-0219-05
Fig.33
White



91-0219-06
Fig.34
White



91-0220-01
Roach



91-0221-01
Vaha



91-0222-01
Beale



91-0223-01
Le Cron

Carving Instruments

ELMED INSTRUMENTS



91-0224-01
Fig.1
PK Thomas

91-0224-02
Fig.2
PK Thomas

91-0224-03
Fig.3
PK Thomas

91-0224-04
Fig.4
PK Thomas

91-0224-05
Fig.5
PK Thomas

APPLICATORI PER SOTTOFONDO



91-0225-00

91-0225-01
Fig.1

91-0225-02
Fig.2

Carving Instruments

ELMED

INSTRUMENTS



91-0226-02
Le Cron



91-0226-03
Le Cron



91-0226-04
Le Cron



91-0227-01
Gritman



91-0228-01
Zahle



91-0228-02
Zahle



91-0229-01
Hylin-Le Cron



91-0230-01
Hylin-Ceramica

Carving Instruments

ELMED INSTRUMENTS



91-0231-01
Fig.1
0.8 mm



91-0231-02
Fig.2



91-0231-03
Fig.3



91-0231-04
Fig.4



91-0231-05
Fig.5



91-0232-01
Le Cran



91-0232-02
Le Cran

Cement Spatulas

ELMED
INSTRUMENTS



91-0233-01



91-0233-02



91-0233-03



91-0233-04



91-0233-05



91-0233-06



91-0233-07

Carving Instruments

ELMED INSTRUMENTS



91-0234-00



91-0234-01
Fig. 1



91-0234-02
Fig. 2



91-0234-03
Fig. 3



91-0235-00

Wax Knives

ELMED
INSTRUMENTS



91-0236-01
Fig. 1
Fahnenstock
12.5 cm

91-0236-02
Fig. 2
Fahnenstock
17 cm



91-0237-01
Fig. 1
Lessmann
12.5 cm

91-0237-02
Fig. 2
Lessmann
17 cm



91-0238-01
Fig. 1
with small spoon
12.5 cm

91-0238-02
Fig. 2
with large spoon
17 cm

Plaster Knives

ELMED
INSTRUMENTS



91-0239-01
Fig. 1
17 cm



91-0239-02
Fig. 2
Gritman
17 cm



91-0239-03
Fig. 3
16 cm



91-0239-04
Fig. 4
16 cm

Spatulas for Plaster and Alginate

ELMED
INSTRUMENTS

Rigid



91-0240-01
Fig. 1
18.5 cm

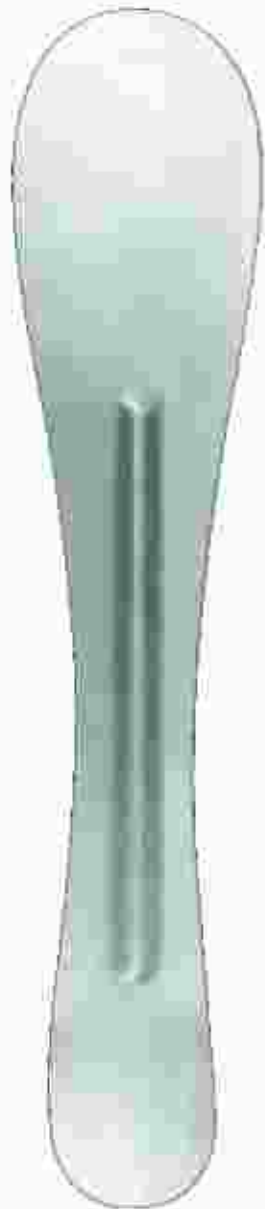

91-0240-02
Fig. 2
18 cm

Flexible



91-0240-03
Fig. 3
18.5 cm



91-0240-04
Fig. 4
19.5 cm



91-0240-05
Fig. 5
21.5 cm



91-0240-06
Fig. 6
20.5 cm

Spatulas for Plaster and Alginate

ELMED
INSTRUMENTS

Flexible



91-0240-07
Fig. 7
18.5 cm

Rigid



91-0240-08
Fig. 8
20 cm

91-0240-09
Fig. 9
22.5 cm

Implant Surgery

ELMED INSTRUMENTS

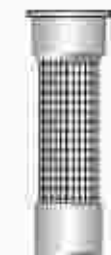

91-0241-27
Spare Filter
large grid
Ø 5mm
27 mm



91-0241-25
Spare Filter
small grid
Ø 5mm
25 mm

Autoclavable



91-0241-00
Bone Filter
200 mm.



91-0242-15
Bone Scraper
Straight
15 cm
Curved
15 cm



91-0243-17
Bone thickness
Gauge
17.5 cm



91-0244-16
Bone Injector
16 cm
Ø 2.5 mm



Bone well
Ø 3.5cm
h. 3.5 cm



91-0245-01
Fig.1
Compactor

91-0245-02
Fig.2
Compactor

91-0245-03
Fig.3
Bone Curette

Implant Surgery

ELMED
INSTRUMENTS



91-0246-19
Partsch
Surgical Mallets:
Lead filling
19 cm



91-0247-19
Partsch
Surgical Mallets:
Autoclavable
Plastic inserts:
19.5 cm



91-0248-01 Fig.1
Freer
91-0248-02 Fig.2
Freer
91-0248-03 Fig.3
Freer

single cut scalpels



91-0249-01 Fig.1
3.8 mm
Straight
91-0249-02 Fig.2
3.8 mm
Curved
91-0249-03 Fig.3
7.5 mm
Straight
91-0249-04 Fig.4
7.5 mm
Curved

Graduated scalpels



Concave end

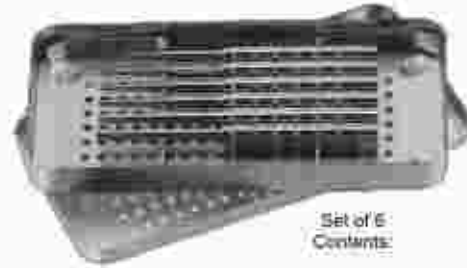

Set of 6
Contents:



91-0250-01
Fig. 1
155 mm
Osteotomes



91-0250-02
Fig. 2
155 mm
Osteotomes



91-0250-03
Fig. 3
155 mm
Osteotomes



91-0250-04
Fig. 4
155 mm
Osteotomes



91-0250-05
Fig. 5
155 mm
Osteotomes



91-0250-06
Fig. 6
155 mm
Osteotomes

Implant Surgery

ELMED INSTRUMENTS



Mini sinus lift kit
Contents!

Mini sinus lift

Annular osteotomes with
selfing point!



91-0251-02
Ø 3.3 mm



91-0251-03
Ø 4 mm



91-0251-04
Ø 5 mm



91-0251-01
165 mm
Ø 3 mm



91-0252-02
Ø 3.3 mm



91-0252-03
Ø 4 mm

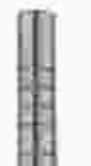

91-0252-04
Ø 5 mm



91-0252-01
165 mm
Ø 3 mm



91-0253-01
165 mm
Ø 3 mm



91-0253-02
Ø 3.3 mm



91-0253-03
Ø 4 mm



91-0253-04
Ø 5 mm



91-0254-01
120 mm
Ø 3 mm

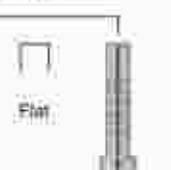

91-0254-02
Ø 3.3 mm

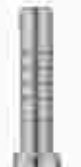

91-0254-03
Ø 4 mm



91-0254-04
Ø 5 mm

Implant site dilators

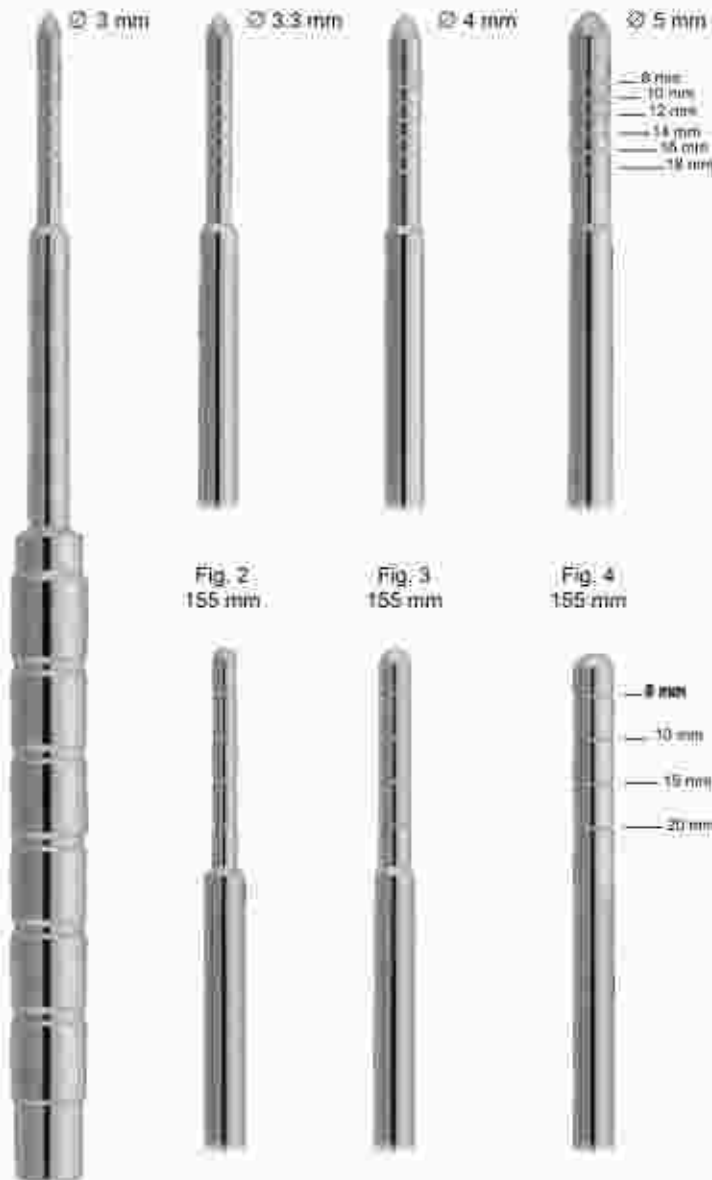

91-0255-01
Fig. 1
155 mm

Fig. 1T
155 mm

Fig. 2T
155 mm

Fig. 3T
155 mm

Fig. 2
155 mm

Fig. 3
155 mm

Fig. 4
155 mm



91-0256-01
Fig. 1
Sinus-lift Curettes

91-0256-02
Fig. 2
Sinus-lift Curettes

Sinus-lift currettes

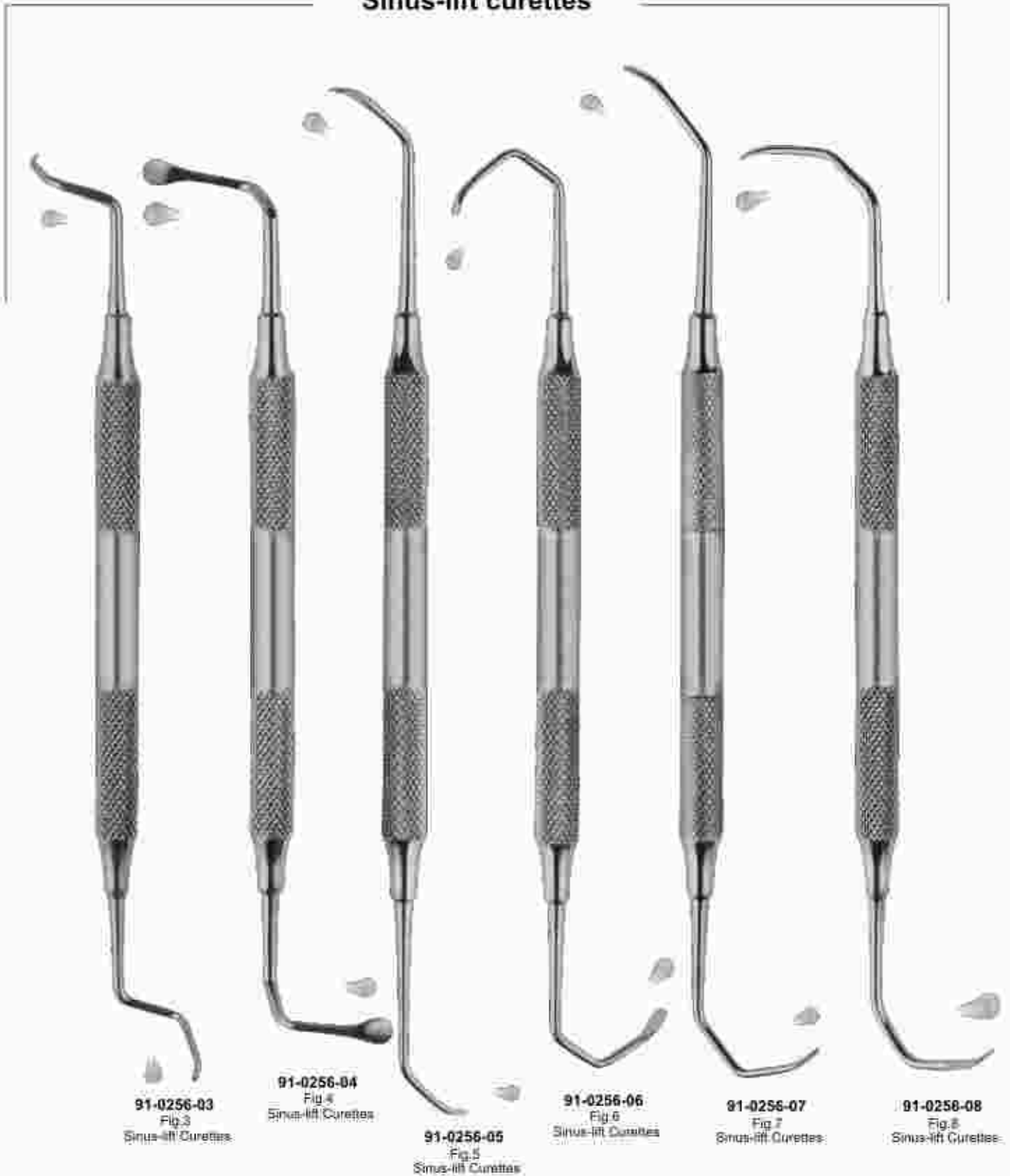

Periosteal elevators



91-0257-01
Fig.1



91-0257-02
Fig.2



91-0257-03
Fig.3



91-0257-04
Fig.4



91-0257-05
Fig.5



91-0257-06
Fig.6

Crown Instruments

ELMED INSTRUMENTS

Crowns and bridges remover



91-0258-00
Crown Remover

Complete with 3 attachments



91-0259-00
Crown Spreader, Crown Remover
Special instrument for crown spreading
after separating, simple and safe
operation.



91-0260-00

Complete with 2 attachments



91-0261-00

Periodontal Instruments



Bone chisels and gouges

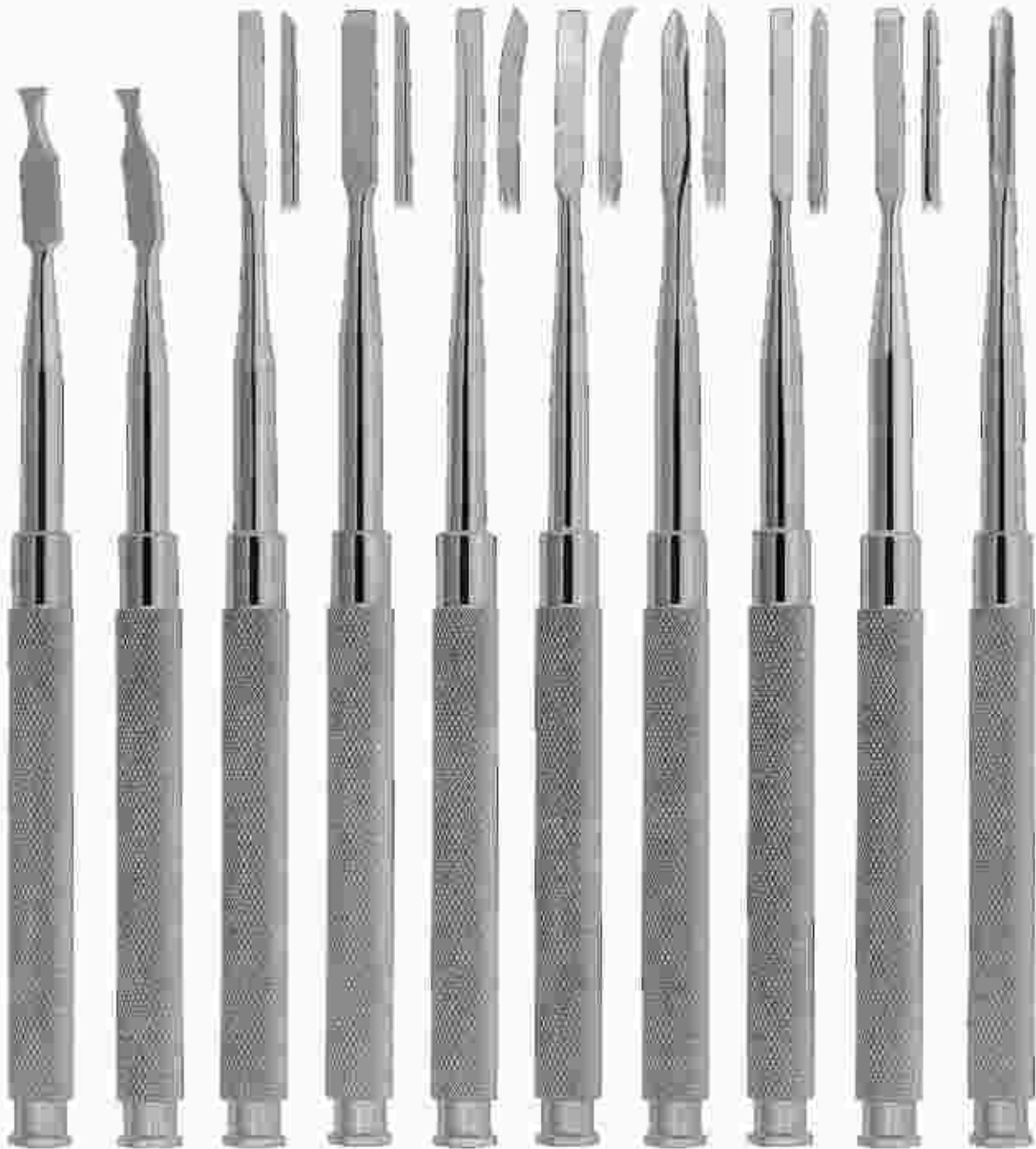

91-0262-01
Fig.1
Ochsenbein

91-0262-02
Fig.2
Ochsenbein

91-0262-01
Fig.1
Gartner

91-0262-02
Fig.2
Gartner

91-0262-03
Fig.3
Gartner

91-0262-04
Fig.4
Gartner

91-0262-05
Fig.5
Gartner

91-0262-01
Fig.1W
Wakefield

91-0262-02
Fig.2W
Wakefield

91-0262-03
Fig.3
Buckley

Periodontal Instruments



Periosteal



Base

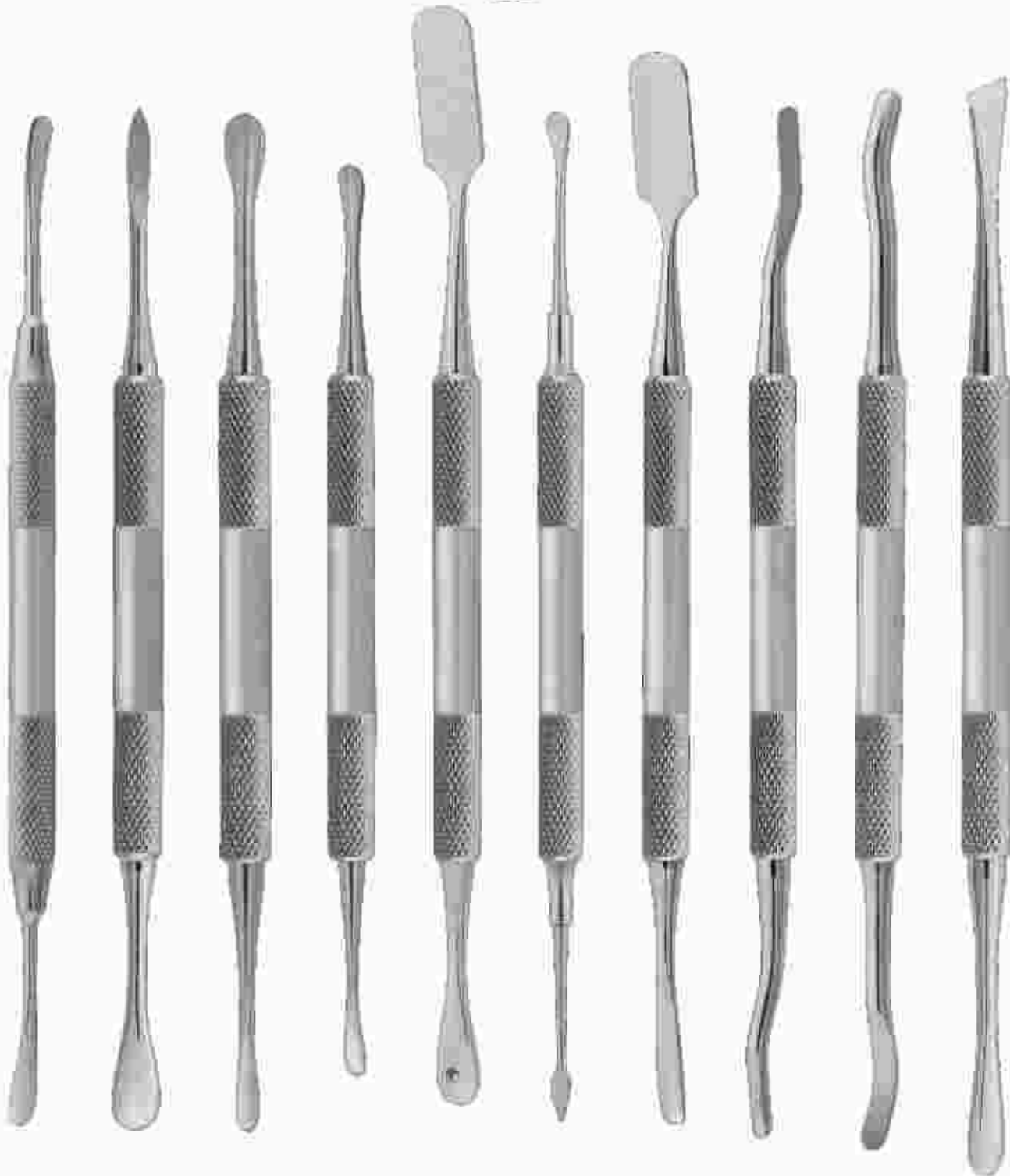

91-0263-01
Fig. GF
Goldman-Fox

91-0264-09
Fig. MB
Mott

91-0264-08
Fig. MB
Mott

91-0264-07
Fig. M7
Mott

91-0265-09
Fig. 9A
Allen

91-0266-02
Fig. 2
Hourigan

91-0267-03
Fig. PR3
Prichard

91-0268-01
Fig. 1
Hopkins

91-0270-02
Fig. 2
Hopkins

91-0267-03
Fig. 3
Mean

Periodontal Instruments

ELMED
INSTRUMENTS

Periosteal and elevators



28-0242-01
18 cm/7"
Freer

28-0242-02
18.5 cm/7 1/4"
Freer

15-0402-15
15.5 cm
Kortig

15-0006-02
14.5 cm
Raetsch

15-0390-22
Fig.22
Seldin retractor

15-0390-23
Fig.23
Seldin retractor

15-0504-01
17 cm
Willinger

15-0504-02
10 cm
Willinger

15-0504-03
18 cm
Willinger

15-0504-04
18 cm
Willinger

Bone Files

ELMED INSTRUMENTS

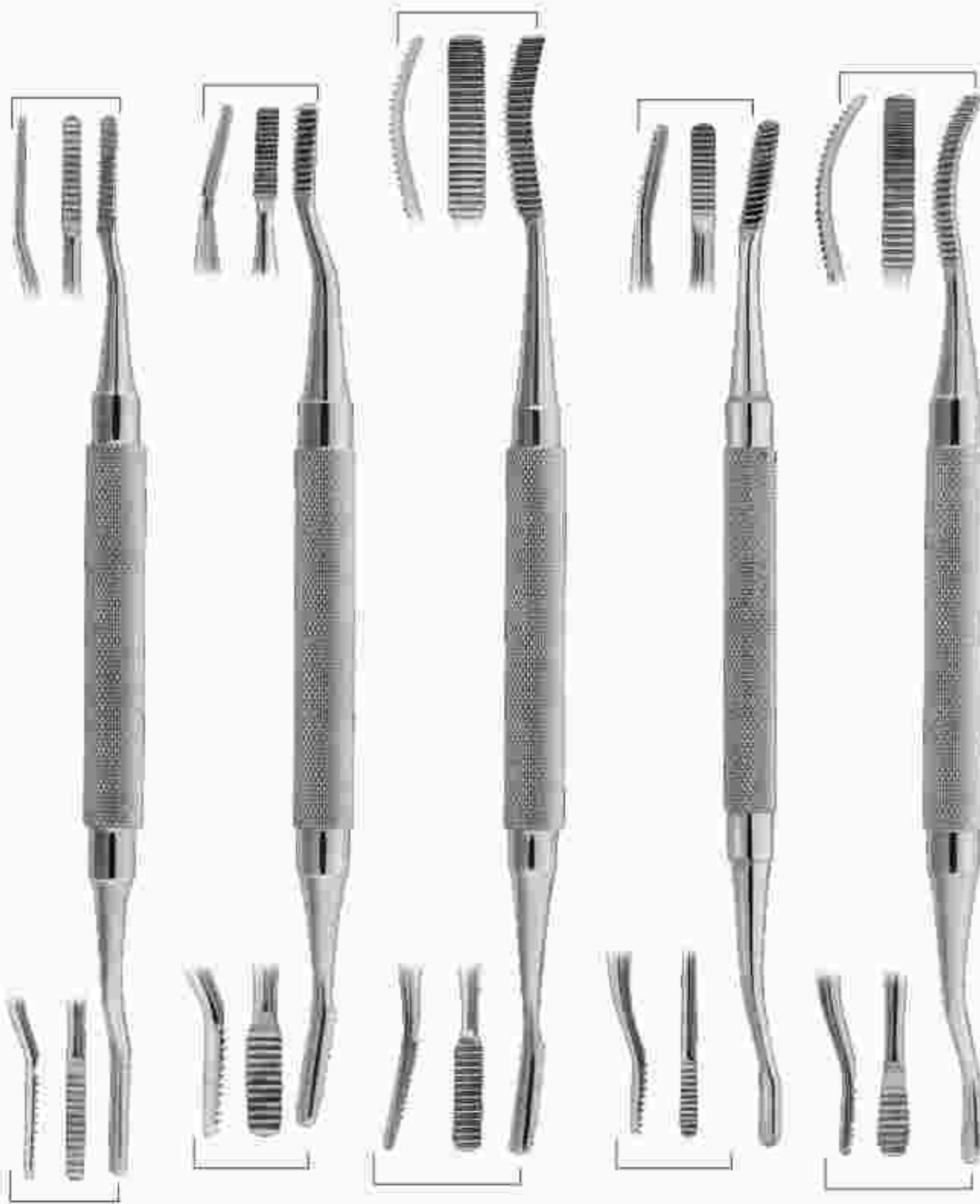

91-0276-01
Fig. 1
Polakoff

91-0277-03
Fig. 33

91-0278-45
Fig. 45
Miller

91-0278-64
Fig. 64
Miller

91-0279-10
Fig. 10

Bone Files

ELMED INSTRUMENTS



91-0280-01
Fig. 1
Wahi



91-0280-02
Fig. 2
Wahi



91-0281-01
Fig. 12
Howard



91-0281-02
Fig. 12A



91-0281-03
Fig. 12CA

Bone Curettes

ELMED INSTRUMENTS



91-0282-01
Fig. 1R/1L
Hemingway



91-0282-02
Fig. 2R/2L
Hemingway



91-0282-03
Fig. 3R/3L
Hemingway



91-0282-04
Fig. 1/1
Hemingway



91-0282-04
Fig. 2/2
Hemingway



91-0283-01
Fig. 1
Mead



91-0283-02
Fig. 2
Mead



91-0283-03
Fig. 3
Mead



91-0283-04
Fig. 4
Mead



91-0283-05
Fig. 5
Mead

Cartridge Syringes

ELMED INSTRUMENTS



1.8 ml
2.2 ml

91-0284-01

91-0284-02

Auto Self Aspirating
(dual action) syringe



1.8 ml
2.2 ml

91-0284-03

91-0284-04

Standard cartridge syringe



1.8 ml
2.2 ml

91-0284-05

91-0284-06

Standard syringe



1.8 ml
2.2 ml

91-0284-07

91-0284-08

Two ring aspirating syringe



1.8 ml
2.2 ml

91-0284-09

91-0284-10

Tri-ring aspirating syringe



1.8 ml
2.2 ml

91-0284-11

91-0284-12

Ring type compression
aspirating syringe



1.8 ml
2.2 ml

91-0284-13

91-0284-14

A type auto self
aspirating
(dual action) syringe



1.8 ml
2.2 ml

91-0284-15

91-0284-16

Single ring aspirating syringe



adapter for all
patients, adult



adapter for all
patients, lung

Cartridge Syringes

ELMED

INSTRUMENTS



Pistol type intraligamentary syringe
mirror finish
1.8 ml
91-0284-17



Pistol type intraligamentary syringe
black handle
1.8 ml
91-0284-18



91-0284-19
Skyp-ject
Miniature intraligamentary syringe 1.5 ml



91-0284-20
Skyp-ject
Miniature intraligamentary syringe 1.5 ml



91-0284-21
17 x 23

91-0284-22
17 x 42

Mouth Mirrors & Handles

ELMED
INSTRUMENTS



Plane
91-0285-01 3=20 mm
91-0285-02 4=22 mm
91-0285-03 5=24 mm



Magnify
91-0285-04 4=20 mm
91-0285-05 5=22 mm



Hilger
91-0285-07
Holder with
welded-on handle
18 cm.



91-0286-01
Hollow Stainless



91-0286-02
Hollow Stainless



91-0286-03
Hollow Stainless



91-0287-04
Solid Stainless

Mirror Handles

ELMED
INSTRUMENTS



91-0288-01
Colour



91-0288-02
Colour



91-0288-03
Colour

Available in colour



91-0289-01
Colour



91-0289-02
Colour



91-0289-03
Colour



91-0289-04
Colour

Mouth Gags

ELMED
INSTRUMENTS



29-0048-13
12 cm
Heister



29-0037-11
11 cm
Molt



29-0037-14
14 cm
Molt



29-0044-12
12 cm
Eberhart



29-0040-16
18/19 cm
Roser-König

Mouth Gags

ELMED INSTRUMENTS



92-6105-00



Kilner-Doughy

29-0004-00
Kilner-Doughy



29-0004-01
Fig.1



29-0004-02
Fig.2



29-0004-03
Fig.3



Mouth Gags

ELMED INSTRUMENTS



Davis-Boyle
Complete
29-0012-00
29-0014-00



27 x 105 mm

29-0012-05

Davis-Boyle



29-0012-04
25 x 92 mm



29-0012-03
25 x 75 mm



29-0012-02
22 x 60 mm



29-0012-01
20 x 25 mm



29-0018-00
Complete
McIvor



27 x 95 mm

29-0018-03

McIvor



29-0018-02
22 x 85 mm



29-0018-01
22 x 70 mm

Mouth Gags

ELMED
INSTRUMENTS



29-0056-11
Whitehead
11 cm
13 cm
15 cm



29-0050-13
Whitehead
13 cm



29-0064-09
Jennings
9 cm
11 cm
13 cm
15 cm



92-0114-09
Seemann-Seiffart
9 cm
11 cm
13 cm
15 cm

Cheek Retractors

ELMED
INSTRUMENTS



92-0115-11
Simplex
11 cm



92-0116-14
Stenberg
14 cm
16 cm
18 cm



92-0117-12
Stenberg
12 cm
14 cm
16 cm



92-0118-19
Mod. Martin
19 cm



92-0119-21
Mod. Martin
21 cm



92-0120-13
Bishop
13 cm

Tongue Depressors

ELMED
INSTRUMENTS



29-0078-19
Mofitz-Schmidt
19 cm



29-0080-15
Hartmann
15 cm



29-0084-01
Tobold
14.5 cm



29-0084-02
Tobold
14.5 cm



29-0132-11
Andrew
11 cm



Wieder



29-0124-01
14 cm



29-0124-02
15 cm

Tongue Depressors

ELMED
INSTRUMENTS

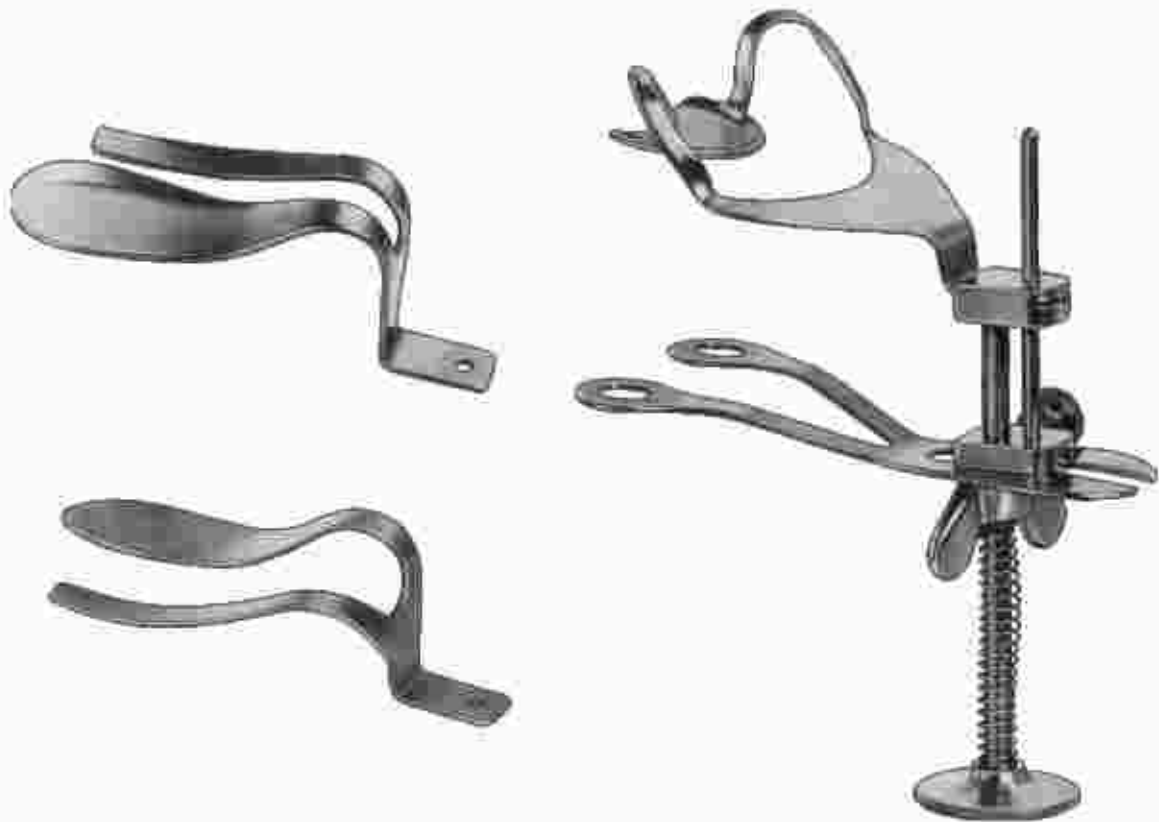

92-0127-01

Tongue depressor and cotton roll holder
with chin support

Tongue Depressors

ELMED
INSTRUMENTS



92-0127-02
16 cm
of wood



92-0127-03
15 cm
of plastic



92-0127-04
16 cm
of acrylic glass



92-0127-05
Buchwald
17 cm
of acrylic glass



92-0127-06
Martin-Boilable
18.5 cm
of nylon
can be autoclave



29-0127-07
14.5 cm



92-0127-08
14.5 cm



92-0127-09
Doyeh
13 cm
16 cm



29-0108-15
Kroenig
15 cm



29-0112-17
Mayo
17 cm



29-0120-19
Breenings
19 cm



92-0127-13
Collin
16.5 cm



92-0127-14
Mod. Martin
16.5 cm



29-0092-16
Fretzel
16.5 cm

Tongue Holding Forceps

ELMED
INSTRUMENTS



29-0136-17
17 cm
Collie



29-0140-17
17 cm
Young



29-0144-19
19 cm
Guy

Scalpel Handles

ELMED

INSTRUMENTS



04-0005-03
No. 3
Standard
Solid



04-0007-03
No. 3
Solid



04-0011-04
No. 4
Solid



04-0043-03
No. 3L
Solid, straight



04-0035-13
No. 3L
Solid, Angled

Scalpel Handles

ELMED
INSTRUMENTS



04-0017-07
No. 7
Solid



04-0019-17
No. 7K
Solid



92-0136-03
No. 3
Hollow, Round



04-0051-05
No. 5
Solid, straight



04-0153-15
No. 5A
Solid, Angled

Bone Chisels and Gouges

ELMED
INSTRUMENTS



4 mm



6 mm



8 mm



4 mm



6 mm



8 mm



10 mm



12 mm



10 mm



12 mm



15-0140-18
18 cm
Mini-Lexer

Handle from artificial wood



15-0144-18
18 cm
Mini-Lexer

Bone Curettes (sharp spoons)

ELMED INSTRUMENTS



Handle from artificial wood

15-0214-40
18 cm
Volkmann

Fig. 0000



Fig. 1

Fig. 000



Fig. 2

Fig. 00



Fig. 3



Fig. 5

Fig. 0



Fig. 4



Fig. 6



15-0210-40
Volkmann

Fig. 0000

Fig. 000

Fig. 00

Fig. 0

Fig. 1

Fig. 2

Fig. 3

Fig. 4

Fig. 5

Fig. 6



15-0228-30
Brute

Fig. 0000

Fig. 000

Fig. 00

Fig. 0

Fig. 1

Fig. 2

Fig. 3

Fig. 4

Fig. 5

Fig. 6

Bone Curettes (sharp spoons)

ELMED
INSTRUMENTS



92-0143-10
16 cm
Mod. USA



Fig. 1



Fig. 2



Fig. 3



Fig. 4



Fig. 5



Fig. 6



92-0144-06
1 to 6



Fig. 1



Fig. 2



Fig. 3



Fig. 4



Fig. 5



Fig. 6



92-0145-06
1 to 6



Fig. 1



Fig. 2



Fig. 3



Fig. 4



Fig. 5



Fig. 6



15-0300-00
13.5 cm
Williger



Fig. 1



Fig. 2



Fig. 3



92-0147-16
16.5 cm
Williger-Mod. Martin



Fig. 1



Fig. 2



Fig. 3

Skin Hooks

ELMED

INSTRUMENTS



11-0019-15
15 cm
Kilner



11-0023-18
18 cm
Giles



11-0057-16
12 cm
Guthrie



11-0050-16
13 cm
Guthrie

Needle Holder

ELMED INSTRUMENTS

All needle Holders are available with TC and without TC



13-0192-12
12.5 cm
Collier



13-0180-13
13 cm/5"
Webster



13-0188-12
12.5 cm
Wright (D&F)



13-0174-13

13-0176-13

Halsey
13.5 cm



13-0198-14
14 cm
Baumgarthel



13-0213-15
13-0213-18
13-0213-20
Mayo-Hegar



15 cm



18 cm



20 cm

Needle Holder

ELMED INSTRUMENTS

All needle Holders are available with TC and without TC



13-0206-13
12.5 cm
Webster "TC"



13-0302-12
12.5 cm
Wight (Bert) "TC"



13-0340-13
12.5 cm
Halsey "TC"



13-0316-14
14 cm
Baumgärtner "TC"



13-0312-14
13-0312-16
13-0312-18
13-0312-20
14 cm
Mayo-Hegar "TC"

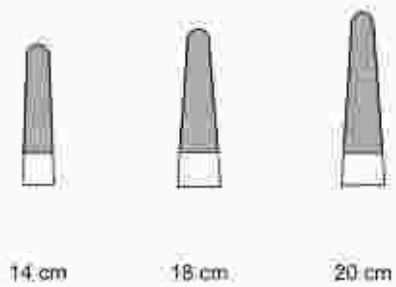

14 cm

18 cm

20 cm

Needle Holder

ELMED INSTRUMENTS

All needle Holders are available with TC and without TC



13-0332-15
15 cm
Baby-Drile-Wood "TC"



13-0336-15
15 cm
Drile-Wood "TC"



13-0452-14
13-0452-17
14/17 cm
Olsen-Hegar "TC"



13-0463-14
14 cm
Gillies-stim "TC"



13-0465-16 L
13-0465-16 R
15.5 cm
Gillies "TC"

Needle Holder

ELMED INSTRUMENTS

All needle Holders are available with TC and without TC:



15 cm

13-0362-15
15/15 cm
Ryder (French Eye) "TC"



15 cm



14 cm

13-0414-14
14/17/18 cm
Mathieu-Kocher "TC"



17 cm



20 cm



13-0444-20
17/20 cm
Hoesel "TC"



13-0410-18
18 cm
Loewen "TC"



13-0398-16
16/18/20 cm
Langenbeck "TC"



16 cm



18 cm



20 cm

Needle Holder

ELMED
INSTRUMENTS

All needle Holders are available with TC and without TC



93-0172-18
18 cm
Castroviejo "TC"



13-0124-13
13 cm
Castroviejo "TC"



93-0174-13
13 cm
Castroviejo



13-0152-13
13 cm
Castroviejo "TC"



93-0176-12
12 cm
Castroviejo-Barricuer

Needle Holder

ELMED

INSTRUMENTS



93-0183-15
15 cm



93-0184-15
20 cm



13-0400-20
20 cm
Lichtenberg



13-0422-20
20 cm
Zweifel

Delicate Scissors

ELMED INSTRUMENTS



07-1121-11
11 cm



07-1122-11
11 cm



07-1055-10
10.5 cm



07-1056-04
10.5 cm

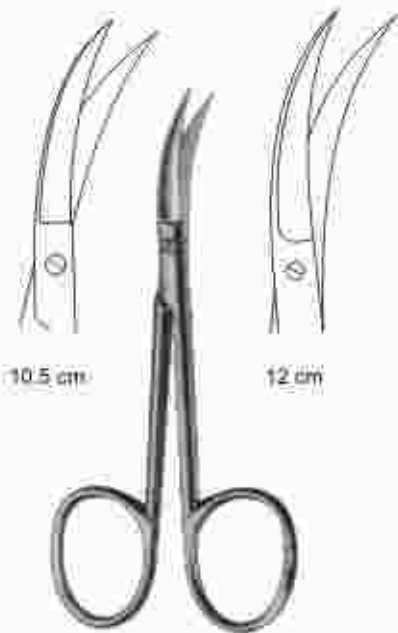

07-1060-10



Iris Standard
94-0100-06

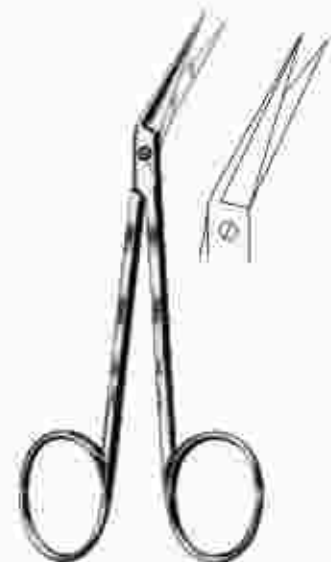

07-1058-11
11.5 cm

Delicate Scissors

ELMED
INSTRUMENTS



07-0491-10
Loxer-Baby
(Knapp)
10 cm



07-0492-10
Loxer-Baby
(Knapp)
10 cm



07-1105-11
12 cm



07-1106-11
12 cm



07-0482-10
10 cm
Walton



94-0100-13
12.5 cm

Operating Scissors

ELMED
INSTRUMENTS



07-0147-10

Standard
13 cm
14.5 cm
15 cm
16.5 cm
17.5 cm



07-0149-10

Standard
13 cm
14.5 cm
15 cm
16.5 cm
17.5 cm



07-0153-18

Standard
13 cm
14.5 cm
15 cm
16.5 cm
17.5 cm

Operating Scissors

ELMED
INSTRUMENTS



07-0166-10
Standard
13 cm
14.5 cm
15 cm
16.5 cm
17.5 cm



07-0168-10
Standard
13 cm
14.5 cm
15 cm
16.5 cm
17.5 cm



07-0170-10
Standard
13 cm
14.5 cm
15 cm
16.5 cm
17.5 cm

Operating Scissors

ELMED INSTRUMENTS



07-0503-14
13 cm
14.5 cm



07-0504-14
13 cm
14.5 cm

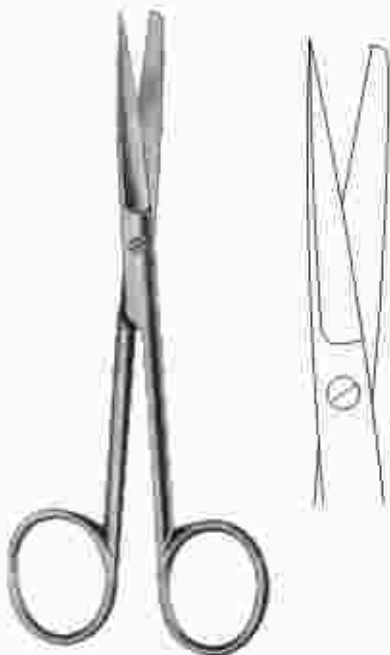

94-0100-22
13 cm
14.5 cm



94-0100-23
13 cm
14.5 cm

Operating Scissors

ELMED
INSTRUMENTS



07-0191-14
Deaver
14 cm

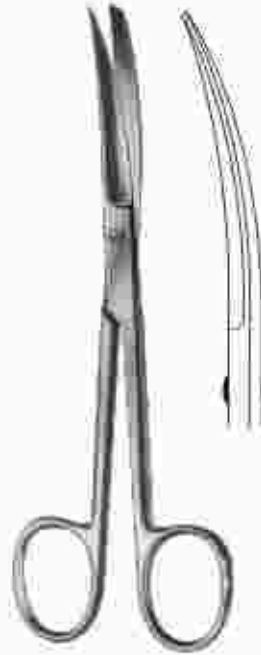

07-0192-14
Deaver
14 cm



07-0193-14
Deaver
14 cm

Operating and Dissecting Scissors

ELMED
INSTRUMENTS



07-0241-14
Mayo
14 cm
17 cm

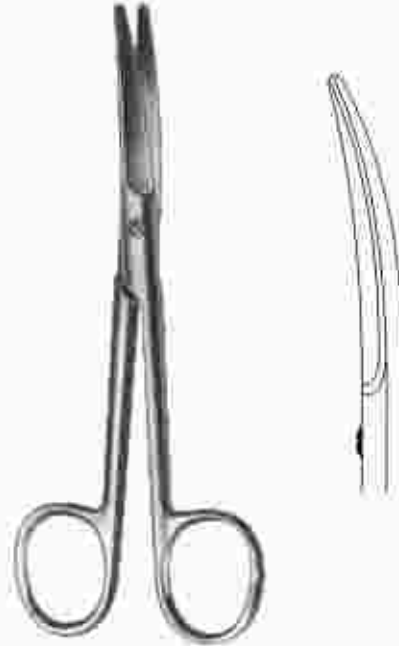

07-0242-14
Mayo
14 cm
17 cm



07-0199-16
Mayo-Lexer
16 cm



07-0200-16
Mayo-Lexer
16 cm

Operating and Dissecting Scissors

ELMED
INSTRUMENTS



94-0100-27
Sistrunk
14 cm

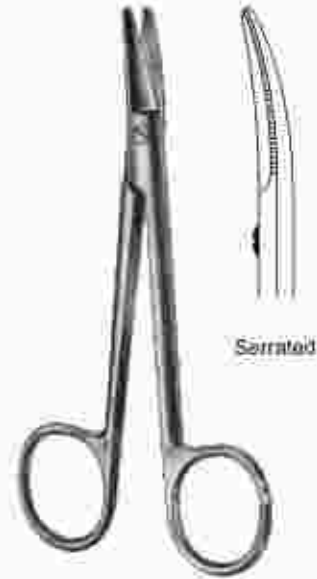

94-0100-28
Sistrunk
14 cm



94-0100-29
Metzgerbaum (Lathey)
14 cm



94-0100-30
Metzgerbaum (Lathey)
14 cm

Operating and Dissecting Scissors

ELMED
INSTRUMENTS



07-0311-18
Metzenbaum
18 cm.



07-0333-18
Metzenbaum
18 cm.



07-0334-14
Metzenbaum-slim
14 cm.



07-0336-14
Metzenbaum-slim
14 cm.



07-0338-18
Metzenbaum-slim
18 cm.



07-0339-18
Metzenbaum-slim
18 cm.

Gum Scissors

ELMED
INSTRUMENTS



07-0388-16
Kelly
16 cm



07-0389-16
Kelly
16 cm

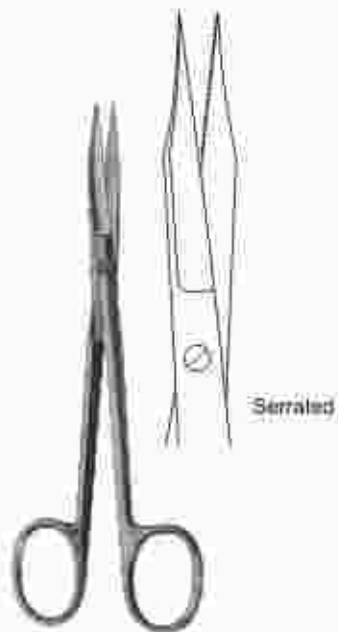

07-1332-13
Fox
13 cm



07-1333-13
Fox
13 cm

Gum Scissors

ELMED
INSTRUMENTS



07-0427-14
Brophy (Sullivan)
14 cm



07-0428-14
Brophy (Sullivan)
14 cm



94-0100-43
'slim'
14 cm



94-0100-44
'slim'
14 cm

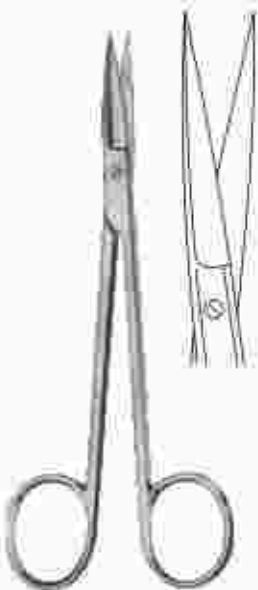

07-0487-14
Sanvenero
14 cm



07-0488-14
Sanvenero
14 cm

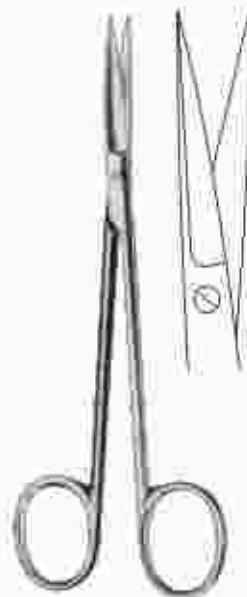

07-0503-14
Joseph
15 cm



07-0204-14
Joseph
15 cm

Gum Scissors

ELMED
INSTRUMENTS

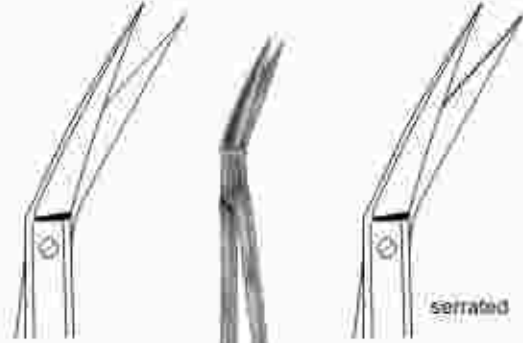
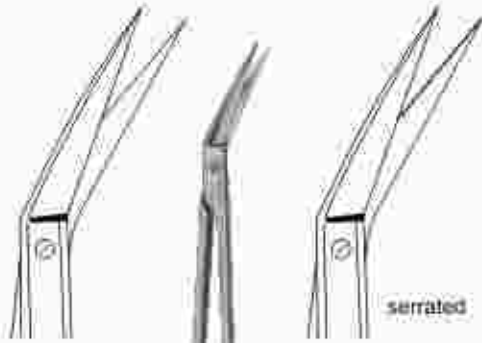

07-1361-16
Locklin
16 cm



07-1363-16
Locklin
16 cm



07-1350-13
Quinby
13 cm



07-1351-13
Quinby
13 cm

Gum Scissors

ELMED

INSTRUMENTS



07-1337-14
Nito
14 cm



07-1114-14
LaGrange
14 cm



07-1115-10
LaGrange
10.5 cm

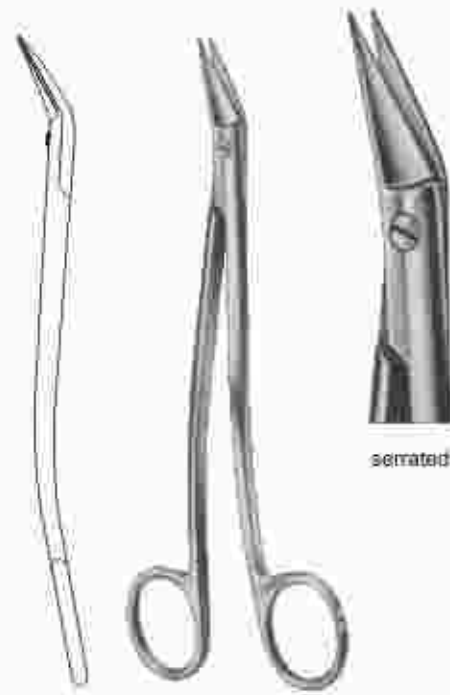

07-1357-17
Dean
17 cm

Tungsten Carbide Scissors

ELMED INSTRUMENTS



07-0334-14
TC
Metzenbaum
14 cm



07-0336-11
TC
Metzenbaum
14 cm



07-0311-18
TC
Metzenbaum
18 cm



07-0333-18
TC
Metzenbaum
18 cm



07-0337-14
TC
Metzenbaum-slim
14 cm



07-0338-14
TC
Metzenbaum-slim
14 cm



07-0339-18
TC
Metzenbaum-slim
18 cm

Tungsten Carbide Scissors

ELMED INSTRUMENTS



94-0100-68
TC
Intra
11.5 cm



94-0100-69
TC
Intra
11.5 cm



07-0157-14
TC
14.5 cm



07-0174-14
TC
14.5 cm

Tungsten Carbide Scissors

ELMED INSTRUMENTS



07-0757-13
TC
Fox
13 cm



07-0758-13
TC
Fox
13 cm

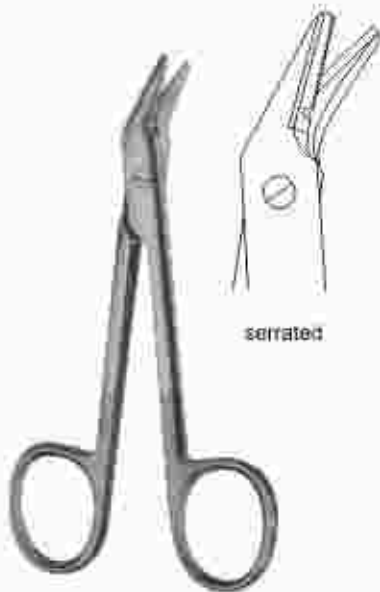

07-0753-12
TC
Universal
12 cm

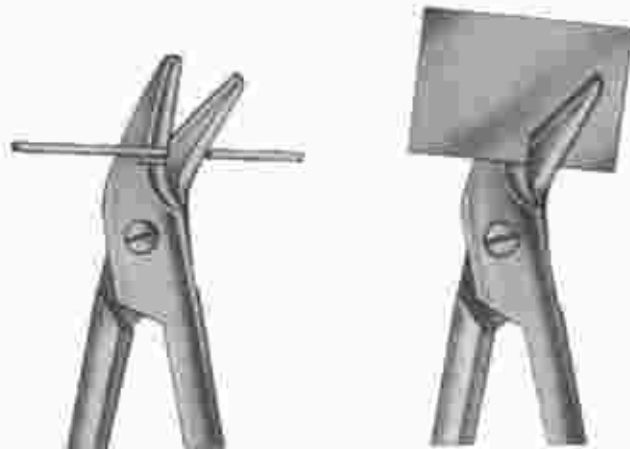

Crown Scissors

ELMED

INSTRUMENTS

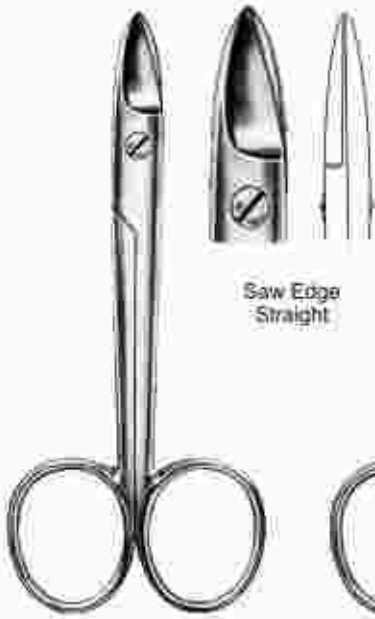

Saw Edge
Straight

07-1328-12
12 cm

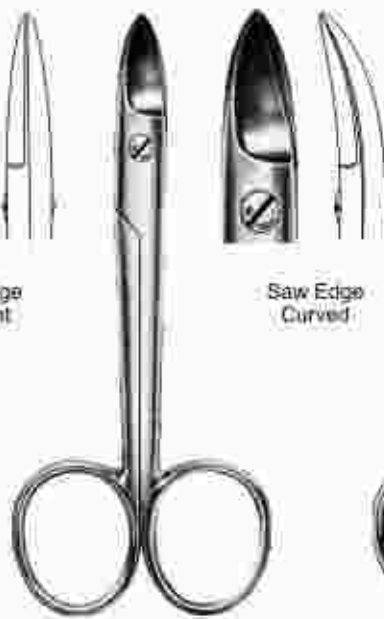

Saw Edge
Curved

07-1329-12
12 cm



07-1332-13
Universal
12 cm

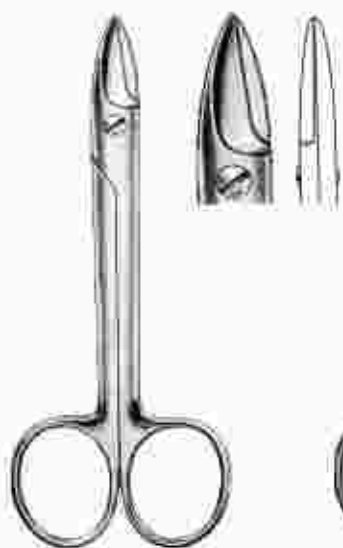

07-1314-10
Beebe
10.5 cm

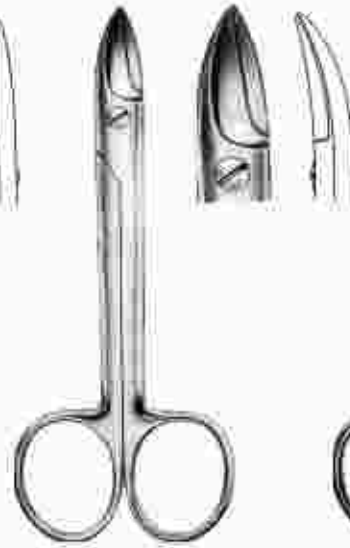

07-1316-10
Beebe
10.5 cm

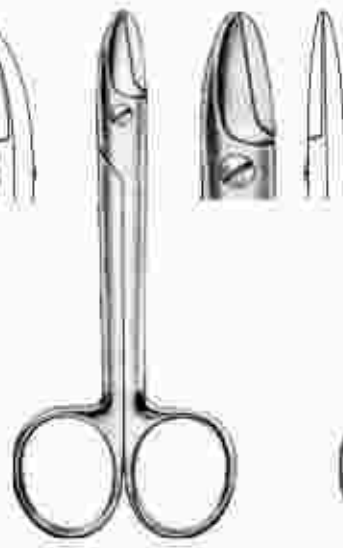

07-1319-10
Beebe
10.5 cm

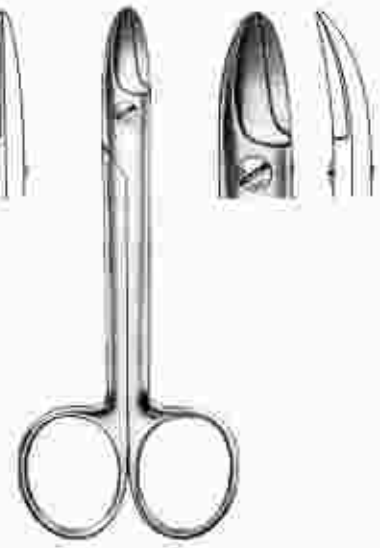

07-1321-10
Beebe
10.5 cm

Stitch Scissors

ELMED
INSTRUMENTS



07-1220-14
Lister
14 cm
18 cm
20 cm



07-1164-12
Martin-Northbent
laterally curved



straight

07-1155-10
Spencer
10.5 cm



angled

07-1168-11
Spencer
11.5 cm



straight

07-1151-13
Littauer
13 cm

Micro Scissors

ELMED INSTRUMENTS



07-0856-11
Westcott
11 cm



07-0826-10
Castroviejo
15 cm



07-0981-16
16 cm

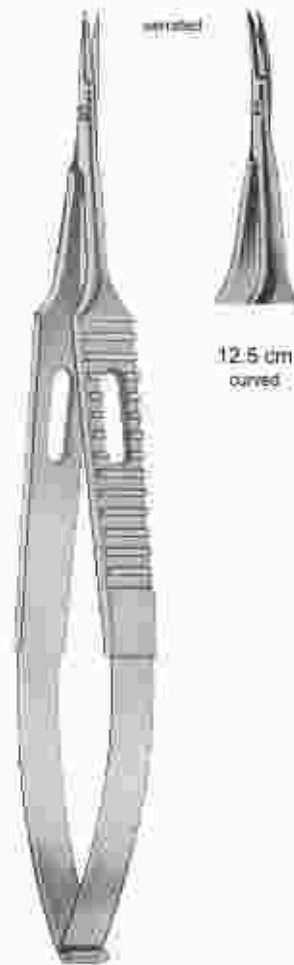

07-0981-12
12.5 cm



07-0981-18
18 cm



18 cm
curved



12.5 cm
curved

Ligature Instruments



94-0101-01 94-0101-02 94-0101-03

Band Seating and removing instrument

Elastic Instruments



94-0102-01

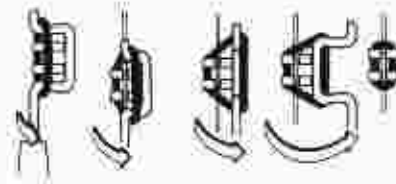

Separating pliers for elastics and separators
15.5 cm

94-0103-15
15.5cm

Rubber Dam Clamp Forceps

ELMED

INSTRUMENTS



94-0104-01
17cm
Ivory



94-0104-02
17cm
Ivory

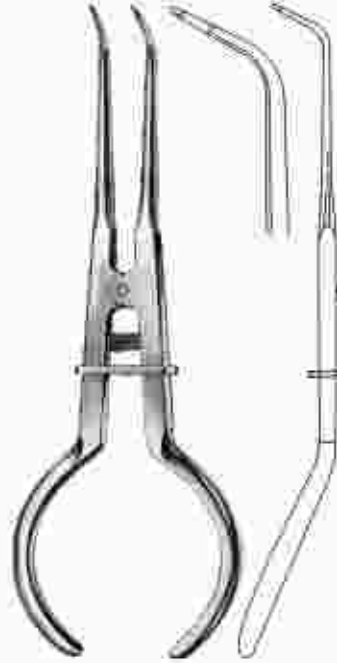

94-0105-17
17cm
White

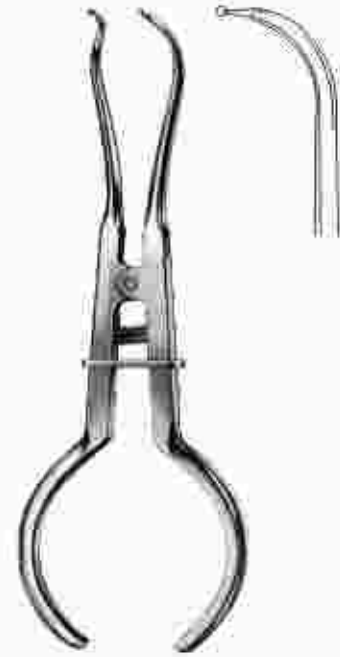

94-0106-17
17cm



94-0107-17
17cm
Palmer

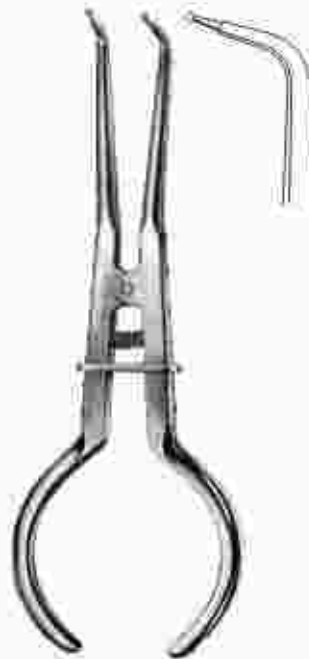

94-0108-17
17cm
Stickles



94-0109-17
17cm
Brewer

Rubber Dam Punch Forceps

ELMED

INSTRUMENTS



94-0110-00



94-0111-17
17 cm
Rosewood



94-0112-16
16 cm
Ivory

Rubber Dam Frame
for Adult

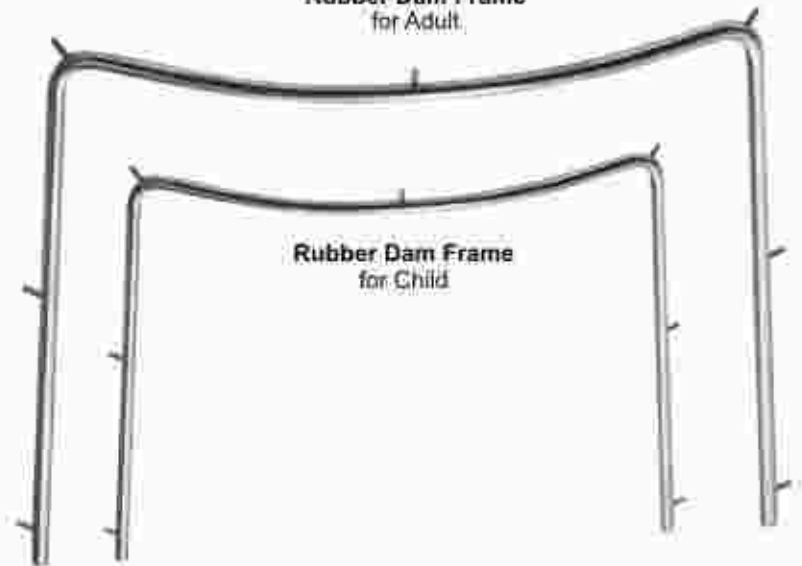

Rubber Dam Frame
for Child

Rubber Dam Clamps

ELMED INSTRUMENTS



94-0113-01
Fig. W8A
For molar roots and partially-erupted or irregularly-shaped small molars.



94-0113-02
Fig. W14
For Partially-Erupted or irregularly-shaped molars



94-0113-03
Fig. W14A
Large molar clamp. Partially-Erupted or irregularly-shaped large molars



Fig. 14A
Large molar clamp. For large Partially-Erupted or irregularly-shaped molars.



94-0113-05
Fig. 14
For Partially-Erupted or irregularly-shaped molars



94-0113-06
Fig. 12A



94-0113-07
Fig. 13A

Right and left molars.



94-0113-08
Fig. 15
Lower Molars. Large molar clamp. Large bow and jaws.



94-0113-09
Fig. 8
Upper Molars.



94-0113-10
Fig. A
For Molar Roots and partially-erupted or irregularly-shaped smaller molars. Jaws have a four-point contact at the corners.



94-0113-11
Fig. 18
Delos Palmer Molar Clamp. Stiff bow.



94-0113-12
Fig. 24



94-0113-13
Fig. 25

Right and left molars
For subgingival cavities on the buccal or lingual surfaces.



94-0113-14
Fig. 3
Lower Molars. Small molar clamp. Flat jaws avoid gum impingement



94-0113-15
Fig. 3
Upper Molars



94-0113-16
Fig. 5
Upper Molars. Large molar clamp.



94-0113-17
Fig. 26
Molar clamps left and right wingless.



94-0113-18
Fig. 28
Molar clamps left and right wingless.



94-0113-19
Fig. 30
Molar clamps left and right wingless.



94-0113-20
Fig. 31
Molar clamps left and right wingless.

Rubber Dam Clamps

ELMED INSTRUMENTS



94-0113-21
Fig. 51
Molar clamps left
and right wingless.



94-0113-22
Fig. 138
Left and right molars.
For third molars.



94-0113-23
Fig. 139
Especially well-suited.



94-0113-24
Fig. 202
Lower molars.
Large molar clamp.



94-0113-25
Fig. 205
Upper molars.
Large molar clamp.



94-0113-26
Fig. 200
Lower molars winged.



94-0113-27
Fig. 201
Lower molars winged.



94-0113-28
Fig. 203
Small molars left
and right winged.



94-0113-29
Fig. 204
Small molars left
and right winged.



94-0113-30
Fig. 00
Narrow jaw for
small bicuspid.
High bow for extra
clearance.



94-0113-31
Fig. 22

For upper and lower bicuspid-wingless.



94-0113-32
Fig. 27



94-0113-33
Fig. 29

Primarily for lower
bicuspid. Broad
flange jaws provide increased
clearance between dam surface
and tooth crown.



94-0113-34
Fig. 206

For upper and lower
bicuspid.



94-0113-35
Fig. 207

For upper and lower
bicuspid.



94-0113-38
Fig. 208
With large jaws
that adapt to large
bicuspid.

Labial Clamps.



94-0113-37
Fig. 209
Primarily for lower
bicuspid. Small
flange jaws for small
bicuspid.



94-0113-38
Fig. 210
For labial cavities
on centrals and bicuspid.



94-0113-39
Fig. 211
Universal clamp for labial
cavities on anterior teeth
and bicuspid.



94-0113-40
Fig. 212
For labial cavities
on anterior teeth.

Cervical Clamps.

Matrix retainers and Matrix Bands

ELMED
INSTRUMENTS



1 m
5 mm

94-0114-01
Ivory
Fig. 8
5 mm



1 m
6 mm

94-0114-02
Ivory
Fig. 8
6 mm



1 m
7 mm

94-0114-03
Ivory
Fig. 8
7 mm



middle
right
direct
and
best

94-0115-01
Fig.1
Nystrom



left
direct
and
best

94-0115-02
Fig.2
Nystrom



1 m
6 mm

Matrix band for Nystrom matrix retainer (Depth 1 mm, width 6 mm)

Matrix retainers and Matrix Bands



94-0116-00
Tofflemire

for molars



94-0116-01
Fig. 1



94-0116-02
Fig. 2



94-0116-03
Fig. 3

for premolars



94-0116-04
Fig. 4



94-0116-05
Fig. 5



94-0116-06
Fig. 6

Matrix bands supplied in packing unit of one dozen



94-0117-01
Fig. 1
Ivory



94-0117-02
Fig. 12
Ivory

with shields
and lock



94-0117-03
Fig. 12A
Ivory



94-0117-04
Ivory

Separators

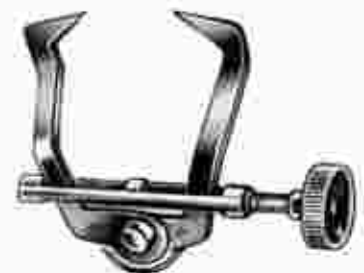

94-0118-00
Elliot

Amalgam Carriers

ELMED INSTRUMENTS



94-0119-05
Single-End

94-0120-15
Distal

94-0121-00
Double-End



2.0 mm
94-0121-01
Mini-Regular



2.0 mm
94-0121-02
Grande-Regular



2.0 mm
94-0121-03
Jumbo-Regular



94-0119-05
Mini-Distal



94-0119-06
Regular-Distal



94-0119-07
Grande-Distal



94-0119-08
MINI-SINGLE-END



94-0119-09
Regular
SINGLE-END



94-0119-10
Grande
SINGLE-END

Amalgam Carriers

ELMED INSTRUMENTS



94-0122-00
210 mm
Ivory



94-0123-00
185 mm
with Metal tip



94-0134-00
185 mm
with Plastic tip



94-0125-00
185 mm
with Plastic tip



94-0126-03
Amalgam Wells
ø 3.5 cm
h 2.5 cm



94-0127-02
Amalgam Wells
ø 2 cm
h 2.5 cm



94-0128-02
Amalgam Wells
ø 2 cm
h 4 cm

Bone Rongeurs

ELMED
INSTRUMENTS



15-0897-15
15.5 cm
Blumenthal



15-0899-15
15.5 cm
Blumenthal

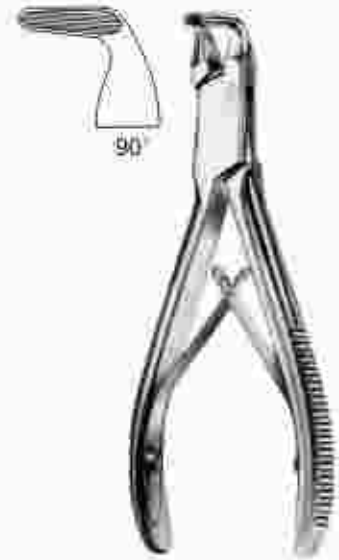

15-0901-15
15.5 cm
Blumenthal



15-0902-04
Blumenthal-S



15-0902-05
18 cm
Blumenthal



15-0869-18
Hartmann

Bone Rongeurs

ELMED
INSTRUMENTS

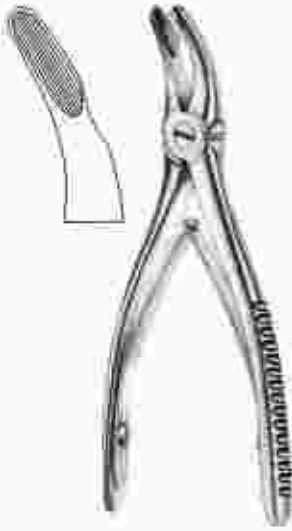

94-0131-00
Universal



15-0877-16
16.5 cm
Mead 1A



15-0879-02
16.5 cm
Mead 2A



15-0854-14
14 cm
Friedman



15-0921-15
15 cm
Luer



15-0923-15
15 cm
Luer

Bone Rongeurs

ELMED
INSTRUMENTS



15-0865-01
Cleveland 3



15-0865-02
14 cm
Cleveland 4



15-0865-03
17 cm
Cleveland 4A



15-1039-17
No. 5
17 cm
Cleveland



15-1039-15
No. 5S
15 cm
Cleveland

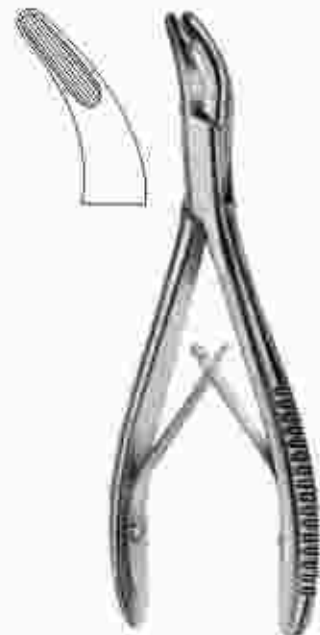

15-1039-10
Cleveland 10

Bone Rongeurs

ELMED INSTRUMENTS

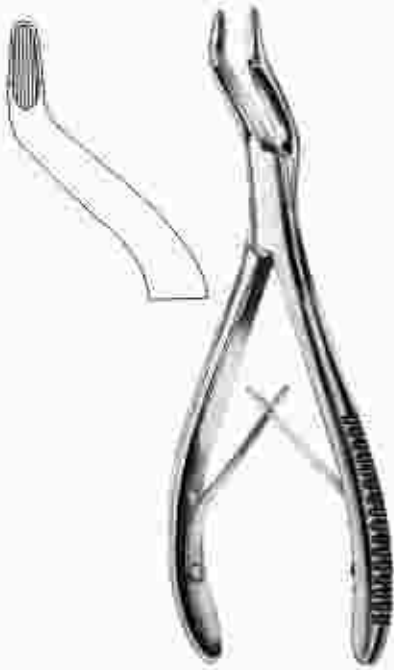

15-0909-16
18 cm



94-0137-12
12 cm
Friedmann-Grazil

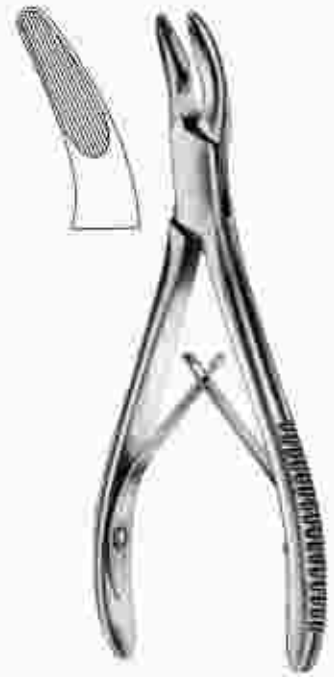

15-0846-17
Bane



15-0893-18
Jansen



15-0894-18
Jansen

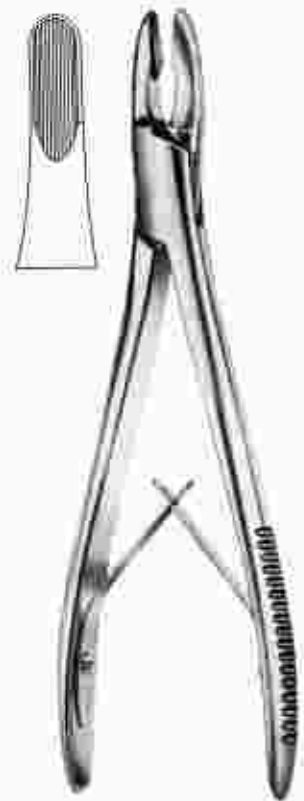

15-0928-20
20 cm/
Adson

Bone Rongeurs

ELMED
INSTRUMENTS



15-0913-17
17 cm
Luer



94-0142-01
16 cm
Cleveland-Gardner



94-0142-02
16 cm
Cleveland-Gardner



15-1039-15
15 cm
Jansson



15-1039-00



15-1039-17

Bone Rongeurs

ELMED
INSTRUMENTS



15-0955-18
18 cm
Fuskir



15-0943-18
18 cm
Bayer



15-1032-14
14 cm
Liston



15-1032-19
19 cm
Liston

Impression Trays

ELMED INSTRUMENTS



94-0152-03-4DR



94-0152-04-4SL



94-0153-05
Check Bite

		A mm.	B mm.
94-0150-01-U1	XXS	56	44
94-0150-01-U2	XS	65	52
94-0150-01-U3	S	68	54
94-0150-01-U4	M	71	58
94-0150-01-U5	L	73	59
94-0150-01-U6	XL	78	63

		A mm.	B mm.
94-0151-02-L1	XXS	56	44
94-0151-02-L2	XS	66	50
94-0151-02-L3	S	70	52
94-0151-02-L4	M	73	56
94-0151-02-L5	L	76	58
94-0151-02-L6	XL	78	60



94-0156-08-1LP



94-0156-08-4SL



94-0157-09-1UP



94-0157-09-4DR

		A mm.	B mm.
94-0154-06-U1	XXS	56	44
94-0154-06-U2	XS	65	52
94-0154-06-U3	S	68	54
94-0154-06-U4	M	71	58
94-0154-06-U5	L	73	59
94-0154-06-U6	XL	78	63

		A mm.	B mm.
94-0155-17-L1	XXS	56	44
94-0155-07-L2	XS	66	50
94-0155-07-L3	S	70	52
94-0155-07-L4	M	73	56
94-0155-07-L5	L	76	58
94-0155-07-L6	XL	78	60

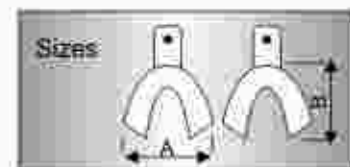
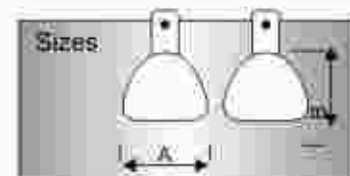

Impression Trays

ELMED INSTRUMENTS



94-0158-10

94-0159-11



94-0160-4DR



94-0160-4SL

		A mm.	B mm.
94-0158-10-U1	XXS	56	44
94-0158-10-U2	XS	65	52
94-0158-10-U3	S	68	54
94-0158-10-U4	M	71	58
94-0158-10-U5	L	73	59
94-0158-10-U6	XL	78	63

		A mm.	B mm.
94-0159-11-L1	XXS	56	44
94-0159-11-L2	XS	66	50
94-0159-11-L3	S	70	52
94-0159-11-L4	M	73	56
94-0159-11-L5	L	76	58
94-0159-11-L6	XL	78	60

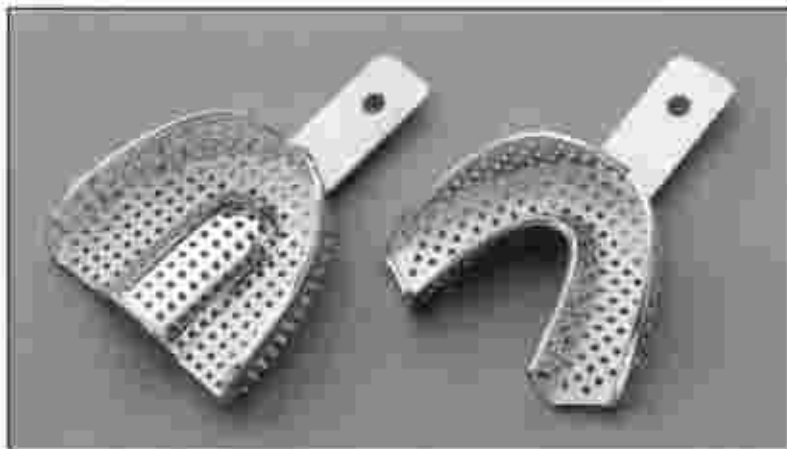

94-0161-13

94-0162-14



94-0163-1UP



94-0163-4DR



94-0163-1LP



94-0163-4SL

		A mm.	B mm.
94-0161-13-U1	XXS	56	44
94-0161-13-U2	XS	65	52
94-0161-13-U3	S	68	54
94-0161-13-U4	M	71	58
94-0161-13-U5	L	73	59
94-0161-13-U6	XL	78	63

		A mm.	B mm.
94-0162-14-L1	XXS	56	44
94-0162-14-L2	XS	66	50
94-0162-14-L3	S	70	52
94-0162-14-L4	M	73	56
94-0162-14-L5	L	76	58
94-0162-14-L6	XL	78	60

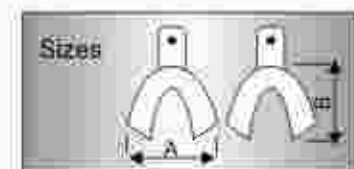
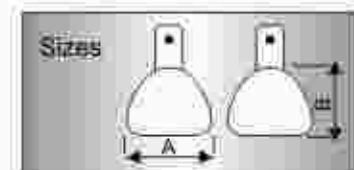

Orthodontic Pliers

ELMED
INSTRUMENTS



94-0164-01
Schwarz
13 cm

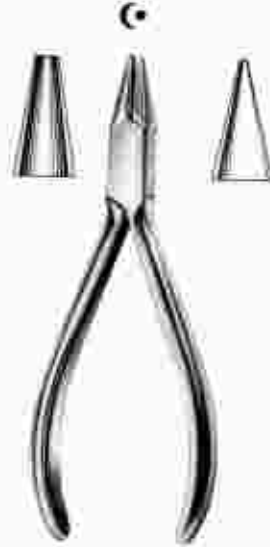

94-0164-02
Schwarz
13 cm



94-0164-03
Schwarz
14 cm

Arch And Spring Bending Pliers

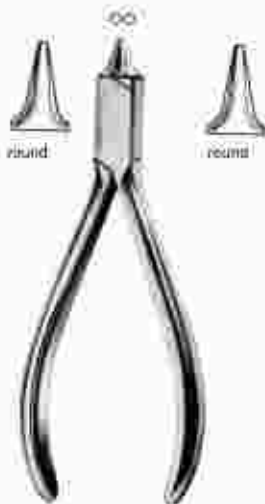

94-0165-12
12.5 cm

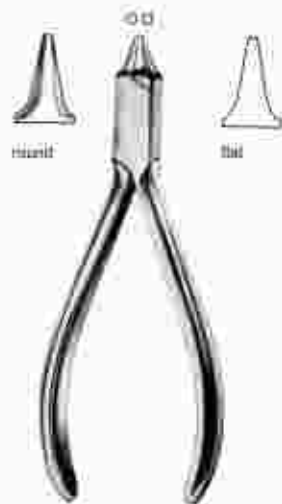

94-0166-13
Angle
12.5 cm

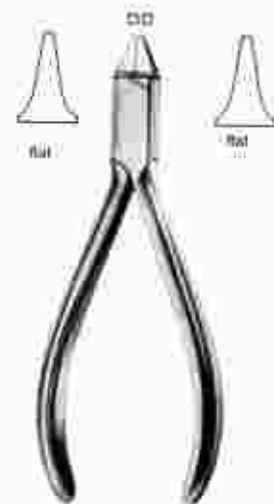

94-0167-13
Adams
12.5 cm

Orthodontic Pliers

ELMED
INSTRUMENTS



94-0168-01
Aderer
11.5 cm



94-0168-02
Aderer
13 cm



94-0169-14
Schwarz
14 cm



94-0170-14
Aderer
14 cm

Wire And Clasp Bending Pliers



94-0171-01
Mc Kellops
16 cm



94-0171-02
Mc Kellops
16 cm



94-0172-21
Malottky
21 cm

Orthodontic Pliers

ELMED
INSTRUMENTS



94-0173-01
Peeso
13 cm

Crown Collar Pliers



94-0173-02
Peeso
13 cm

Crown Collar Pliers



94-0174-13
Fravert
13 cm



94-0175-13
Gordon
13,5 cm



94-0176-13
Lisa Modell
13,5 cm



94-0177-14
Goslee
13,5 cm

Orthodontic Pliers

ELMED INSTRUMENTS



94-0178-15
Waldsachs
15 cm

Wire twister and ligature pliers



94-0179-01
16 cm

Universal Fin Bending Pliers



94-0179-02
16 cm



94-0180-01
Schwarz
12.5 cm



94-0180-02
Schwarz
13 cm



94-0181-00
Young

Orthodontic Pliers

ELMED
INSTRUMENTS



94-0182-18
MontFort
18 cm

Crown Slitter



94-0183-16
Baade
16 cm

Copper Ring Removing Pliers



94-0184-15
Furrer
15 cm

Copper Ring Removing Pliers



94-0185-01
How-Str
14 cm



94-0185-02
How-Cur
13.5 cm



94-0186-15
Collar Plier
14.5 cm

Orthodontic Pliers

ELMED
INSTRUMENTS



94-0187-16
Bohm
16 cm

Telescope Crown Pliers



94-0188-13
Wire-Bending
Plier
13 cm



94-0189-13
Side Nipper
13 cm



94-0190-13
End Nipper
13 cm



94-0191-16
Side Cutter of
Chrome-Vanadium
Steel
16 cm



94-0192-14
Angle
Band Forming Plier
14.5 cm

Orthodontic Pliers

ELMED

INSTRUMENTS

SKIPLINE

TC



94-0193-01
Hard Wire Cutter, Chrome

TC

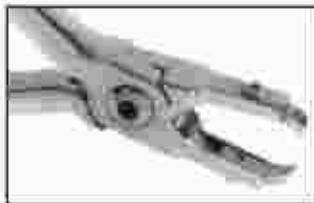

94-0193-04
Direct Bond Remover, Wide



94-0193-07
Posterior Band Remover, Long

NEW!



94-0193-10
Direct Bond Bracket Remover,
(Wide, Replaceable Tip and Pad)



94-0193-13
Loop Forming Plier, Tweed Style

TC



94-0193-02
Detailing Step Plier



94-0193-05
Bird Beak Plier



94-0193-08
Light Wire Plier

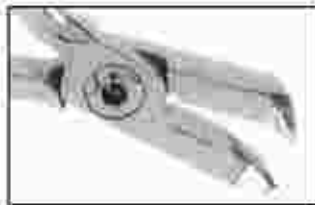

94-0193-11
Cinch Back Plier

TC



94-0193-14
Weingart Utility Plier

TWEED

TC



94-0193-03
Mini Pin and Ligature Cutter

TC



94-0193-06
45° Ligature Cutter



94-0193-09
Distal End Cutter, Flush Cut,
with Safety Hold



94-0193-12
Flush Cut, Distal End Plier

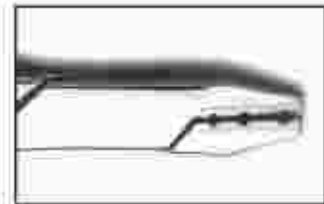

94-0193-15
Face Bow Adjusting Plier

Orthodontic Pliers

ELMED INSTRUMENTS

SKIPLINE



94-0193-16
Omega Loop Forming Plier,
Tweed Style



94-0193-19
Jarabak Plier



94-0193-22
Lingual Arch Forming Plier



94-0193-25
Rectangular Arch Forming Plier



94-0193-27
Utility Plier (Weingart Style, Slim Tips)

TC



94-0193-17
Distal End Cutter,
Safety Hold



94-0193-20
Small Distal End Cutter,
Safety Hold



94-0193-23
Long Handled Distal End Cutter



94-0193-26
Straight Utility, How Style



94-0193-28
Offset Utility Plier, How Style

TWEED

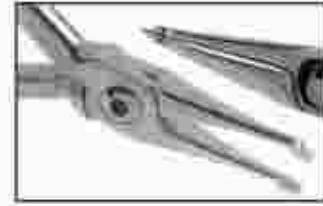

94-0193-18
Band Seating Plier



94-0193-21
Ball Hook Crimping Plier



94-0193-24
Angled Ball Hook Crimping Plier

TC



94-0193-25
Rectangular Arch Forming Plier

TC



94-0193-27
Utility Plier (Weingart Style, Slim Tips)

NEW!

Articulators

ELMED INSTRUMENTS



94-0194-01

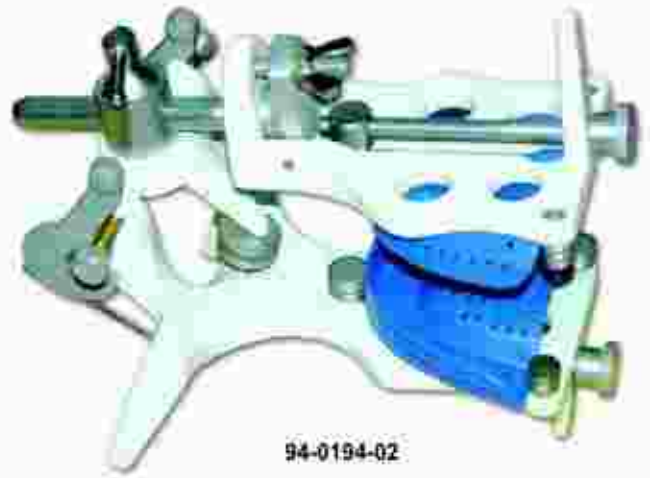

94-0194-02



94-0194-03



94-0194-04



94-0194-05

94-0194-05
No. 17U



94-0194-05
No. 15U



94-0194-05
No. 13U



94-0194-05
No. 13L



94-0194-05
No. 14L

Stainless Steel Instruments Trays

ELMED INSTRUMENTS

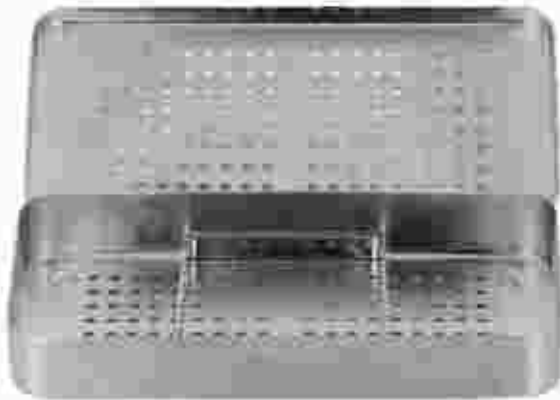

94-0195-01

Perforated instrument tray complete, with insert frame for 7 instruments, dimensions 200 mm x 100 x 30

Perforated lid, dimensions 200 mm x 100 x 10

Perforated base, dimensions 200 mm x 100 x 30

Instrument tray complete, with insert frame for 7 instruments, dimensions 200 mm x 100 x 30

Lid, dimensions 200 mm x 100 x 10

Base, dimensions 200 mm x 100 x 30



94-0195-02



Insert frame for 7 instruments

94-0193-03



94-0195-04

MAXI-inox tray dimension 150 mm x 200 mm



94-0195-05

MINI-inox tray dimension 150 mm x 200 mm



94-0195-06

Kidney tray dimension 170 mm x 100 x 200



94-0195-07

Kidney tray dimension 250 mm x 140 x 40

Stainless Steel Instruments Trays

ELMED
INSTRUMENTS



Perforated lid, dimensions 288 mm x 187 x 29

Perforated base, dimensions 284 mm x 183 x 17

Perforated instrument tray complete, with insert frame for 16 instruments, dimensions 288 mm x 187 x 39

Perforated instrument tray complete, with insert frame for 23 instruments, dimensions 288 mm x 187 x 39

94-0195-08



Lid, dimensions 288 mm x 187 x 29

Perforated base, dimensions 284 mm x 183 x 17

Instrument tray complete, with insert frame for 16 instruments, dimensions 288 mm x 187 x 39

Instrument tray complete, with insert frame for 23 instruments, dimensions 288 mm x 187 x 39

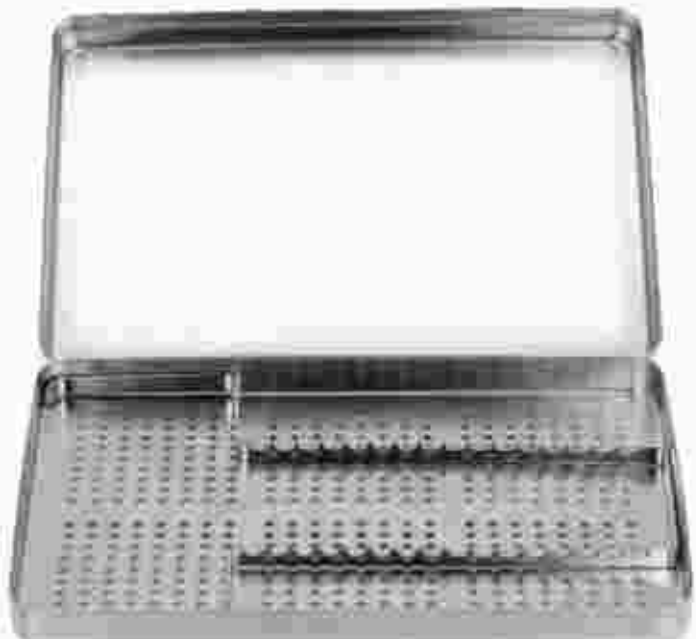

94-0195-09

Aluminum Instruments Trays

ELMED
INSTRUMENTS

Aluminum color coated instrument trays - STANDARD dimensions



94-0195-10
Color Coated base
dimensions mm. 284 x 183 x 17



94-0195-11
Color Coated base
dimensions mm. 284 x 183 x 17



94-0195-12
Color Coated base
dimensions mm. 284 x 183 x 17



94-0195-13
Color Coated base
dimensions mm. 284 x 183 x 17



94-0195-14
Color Coated base
dimensions mm. 284 x 183 x 17



94-0195-15
Lid - grey only
dimensions mm. 288 x 187 x 29

Insert frames



94-0195-16
Insert frame for 11 instruments



94-0195-17
Insert frame for 17 instruments

Stainless Steel Instruments Trays

ELMED

INSTRUMENTS



Lid, dimensions 286 mm x 187 x 29

Base, dimensions 284 mm x 183 x 17

Instrument tray complete, with insert frame for 16 instruments, dimensions 288 mm x 187 x 39

Instrument tray complete, with insert frame for 23 instruments, dimensions 288 mm x 187 x 39

94-0195-18

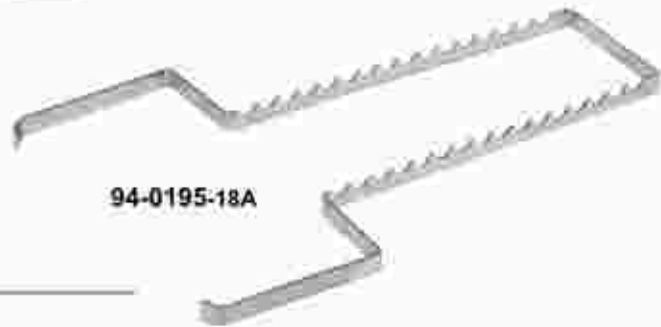

94-0195-18A

Insert frame -STANDARD- for 16 instruments



94-0195-18B

Insert frame -STANDARD- for 23 instruments

Sterilizing Forceps



20 cm
94-0195-19



30 cm
94-0195-20

Aluminum Instruments Trays



Aluminum color coated instrument trays - STANDARD dimensions - Perforated

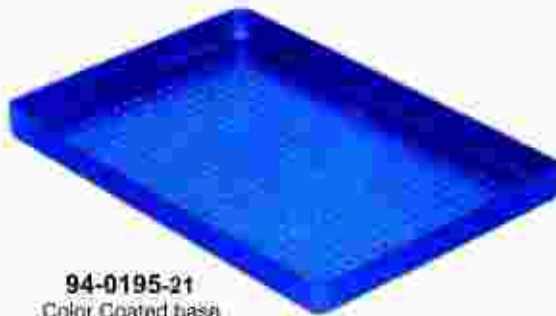

94-0195-21
Color Coated base
dimensions mm. 284 x 183 x 17



94-0195-22
Color Coated base
dimensions mm. 284 x 183 x 17



94-0195-23
Color Coated base
dimensions mm. 284 x 183 x 17



94-0195-24
Color Coated base
dimensions mm. 284 x 183 x 17



Color Coated base
dimensions mm. 284 x 183 x 17

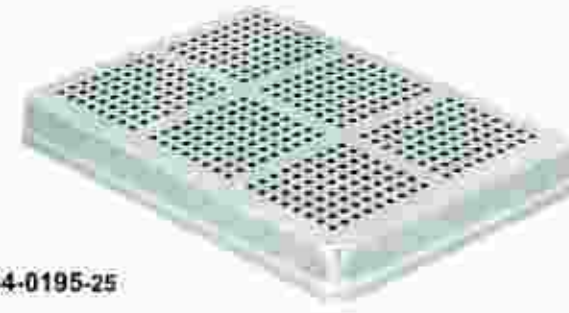

Lid - grey only
dimensions mm. 288 x 187 x 29



Insert frames



94-0195-25A

Insert frame for 10 instruments



94-0195-25B

Insert frame for 11 instruments

Endodontic Boxes

ELMED
INSTRUMENTS



94-0195-26



94-0195-27



94-0195-28



94-0195-29

Aluminum endodontic MINI boxes, complete with lid - dimensions mm. 100 x 44 x 54



94-0195-30



94-0195-31



94-0195-32



94-0195-33

Spare glasses for Endo-Box

Round aluminum endodontic boxes, complete with lid

Ø 48mm - H 62mm



94-0195-34

Ø 94mm - H 70mm



94-0195-35

Endodontic Boxes

ELMED
INSTRUMENTS



94-0195-36



94-0195-37

Aluminum endodontic MAXI boxes,
complete with lid
dimensions mm. 204 x 105 x 54



94-0195-38



94-0195-39



94-0195-40

Aluminum endodontic MIDI boxes,
complete with lid
dimensiona mm. 125 x 105 x 54



94-0195-41



94-0195-42

Instrument Trays

ELMED
INSTRUMENTS



94-0196-01

MIDI
Dimensions: 182 x 144 x 34
Locking tray medium for 10 instruments
complete with base, lid, silicone insert frame and holder.



94-0196-02

MIDI-2
Dimensions: 182 x 144 x 34
Locking tray medium for 5 instruments
complete with base, lid, silicone insert frame and holder.



94-0196-03

MIDI-2
Dimensions: 182 x 72 x 34
Locking tray medium for 5 instruments
complete with base, lid, silicone insert frame and holder.



Silicone instrument holder
for (10 pcs)

94-0196-0A

Silicone instrument holder
for (5 pcs)



Silicone insert frame for (10 pcs)

94-0196-0B

Silicone insert frame for (5 pcs)



Instrument Trays

ELMED
INSTRUMENTS



94-0196-04
STANDARD
Dimensions: 298 x 182 x 34

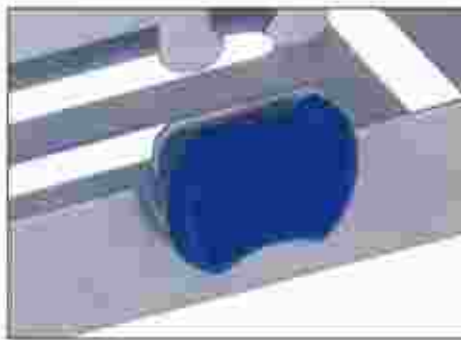

Locking System



94-0196-05
MIDI
Dimensions: 182 x 144 x 34



94-0196-06
MINI
Dimensions: 182 x 72 x 34

INDEX

ELMED
 INSTRUMENTS

A

ABDOTT, Bone	52
ADAMS, Orthodontic File	178
AFFREN, Orthodontic File	178
ADSCAL, Bone Forceps	173
ALBRECHT, Root Elevator Forceps	52
ALLEN, Root Elevator Forceps	53
ALLEN, Periodontal Instrument	115
AMALGAM CARVERS	13-94, 188
ANDREW, Single Depression	123
AND E, Orthodontic File	178
APICAL STANDARD, Root Elevator	54
ARTHUR, Single Forceps	51
ARTICULATORS	188
ASA, Filing Instruments	63

B

BADY-GRIE WOOD	141
BAADE, Orthodontic File	182
BADE, Bone Forceps	173
BARKY, Root Elevator	39
BARNATHEN, Needle Holder	129-140
BEALE, Carving Instrument	96
BEBE, Crown Scissors	156
BEIC, Root Elevator	51-56
BERNARD, Root Elevator	44
BERN, Bone Forceps	175
BISHOP, Forceps	128
BLACK, Scaler	55
BLACK, Dental Instrument	72
BLACK, Amalgam Contactor	81
BLACK, Hooked	82
BLUMENTHAL, Bone Forceps	170
BONE CURETTE	106
BONE FILE	117-118
BONE RUTER	106
BONE INJECTION	100
BONE HOLELASS	170-171; 172-173-174
BONE SCRAPER	188
BONE THICKNESS	106
BONE WELL	106
BROPHY (Sillman) Bone Section	152
BRENNING, Single Depression	131
BUCKLEY	114
BREWER, Rubber Dam Clamp Forceps	163
BRUNS, Bone Curette	120

C

CAMPBELL, Extracting Forceps	10
CARTRIDGE SYRINGES	120-121
CASTROVIEJO	160
CEMENT SPATULAS	100-101
CHOMPERS, Root Elevator	40
CLEVELAND, Bone Forceps	172
CLEVELAND-GARDNER, Bone Forceps	174
CLIMBE, Scaler	56
COHEN, Extracting Forceps	13-25
COLSMAN, Extracting Forceps	12
COLEMAN, Root Elevator	50
COLLIER, Needle Holder	119
COLLIN, Single Depression	131
COLLIN, Single Hooking Forceps	102
COLLIER FLIER	162
COLUMBIA, Scaler	57
COMPACTOR	106
COMPGARD, Root Elevator	39
CRANE-KAPLAN	68
CRILE-WOOD, Needle Holder	141
CROSS (Hook) & System	76

CRUER, Extracting Forceps	28
CRUER, Root Elevator	33
CROWN REMOVER	113
CROWN SCISSORS	158
Cement Spatulas	

D

DAVIS-BOYLE, Mini-Clamp	125
DEAR, Cup System	154
DEWEN, Operating Instrument	147
DELICATE SCISSORS	142-143
DEWITT, Root Elevator	124
DEWY-PERRY, Scaler	55
DEWY-PERRY, Extractor	77
DISTAL, Amalgam Contactor	188
DOYON, Tongue Depressor	131

E

ELASTIC, Instrument	101
ELLIOTT, Filing Instrument	88
ELLIOT, Depression	167
ENDODONTIC INSTRUMENTS	29
ENDODONTIC MIXERS	190-193
EXTRACTING Forceps	01-02

F

FAHRENSTOCK, Wire Forceps	102
FELNER, Extracting Forceps	03-05
FELSCH, Extracting Forceps	12
FILING INSTRUMENTS	88-90-91-92
FREVERY, Orthodontic File	180
FRIEDMAN, Root Elevator	39
FRIEDMAN, Bone Forceps	171
FRIEDMAN-GRAZEL, Bone Forceps	173
FREE, Implant Surgery	137
FREE, Professional File	116
FRENZEL, Tongue Depressor	131
FLADD, Crown & Dressing File	53
FLOHR, Root Elevator	38
FOX, Cup & Vamplate Cupping System	141-152
FURBER, Orthodontic File	182

G

GARDNER, Bone Drill & Coaps	114
GMB, Extracting Forceps	12
GILLET, Extractor	74
GILLES, Saw Hook	134
GILLES, Needle Holder	143
GILLES-SUM, Needle Holder	141
GRANDESTADT, Hook	01
GOLDMAN-FOX	57-69-115
GORDON, Orthodontic File	180
GOSLES, Orthodontic File	180
GLOBE, Scaler	60
GRACEY-CURETTES	49-63
GRIFFIN, Carving Instrument	88
GRIFFIN, Needle Holder	103
GUENTHER, Scaler	66
GUTHRIE, Saw Hook	138
GUY, Single Hooking Forceps	122

H

HALLEY	135-140
HARRIS, Extracting Forceps	22
HARTMANN, Tongue Depressor	725
HARTMANN, Bone Forceps	172
HEIDENHAIN, Steel Elevator	47-49
HEIDMANN, Frig Instruments	81
HEIMOWY, Bone File	119
HENAHAN, Extracting Forceps	20
HESTER, Mouth Gag	124
HOLLENBACH, Anesthetizer-Catheters	82
HOPKINS	115
HOURIGAN	115
HOWISE & Co. J Orthodontic Plar	182
HOWARD, Bone File	119
HULL, Extracting Forceps	25
HYGIENIST, Scaler	59
HYUN, Root Elevator	36
HUNLEIGH	88
HUNTERMAN	88

I

IMPLANT SURGERY	100-107-108-109-110-111-112
IMPRESSION TRAYS	176-177
INSTRUMENTS TRAYS	107-109-110
IOD, Scaler	142
IVORY, Rubber Gum-Dama Forceps	162
IVORY, Metal Retainer	166-167
IVORY, Anesthetizer-Catheter	88

J

JANSEN, Bone Remover	175-174
JENNINGS, Mouth Gag	27
JOHNSON, Anesthetizer-Catheter	82
JOSEPH, Gum Sucker	163
JOLETTE, Scaler	58

K

KASER, Extracting Forceps	22
KELLER, Extracting Forceps	25
KELLY, Gum Sucker	161
KILNER-DOUGHTY, Mouth Gag	126
KILNER, Saw Handle	138
KIRKLAND, Periodontal Instruments	84
KOCHER, Extracting Forceps	27
KOVIS, Periodontal Inc	118
KOYF, Root Elevator	45-46
KRAUSEMEYER, Bone Elevator	43
KREML, Periodontal Probe	70
KRENG, Tongue Depressor	131

L

LADMORE, Extracting Forceps	11
LADMORE, Frig Instruments	84
LADMORE, Frig Instruments	154
LA GRANGE, Gum Sucker	70
LARGE, Perfect E-Extractor	53
LANDGRAF, Gum & Drawing Plar	47
LECLUSE, Root Elevator	37-38-39
LE CROM, Carving Instruments	102
LESSMANN, Vial Holder	143
LESTER BIRD, Sucker	165
LIDATURE, Instruments	48-49
LINDLEVIN, Root Elevator	159
LISTER, Root Sucker	175
LITTON, Bone Remover	159
LITTLER, Scaler	50-51
LOGGIER, Gum Sucker	171-174
	80

L

LONDON COLLEGE, Gum & Drawing Plar	80-81
LUER, Gum Sucker	171-172
LUKE, Periodontal Instruments	80

M

MALOTKY, Orthodontic Plar	178
MARTIN-HORTHENT, Scaler	168
MATH, RETAINER	168
MAYO-HEAGER, Needle Holder	119-145
MAYO, Operating & Drawing Sucker	166
MAYO-PARR, Operating & Drawing Sucker	145
MAYO, Tongue Depressor	171
MC CALL, Scaler	58
MC CALL, Periodontal Instruments	88
MC IVOR, Mouth Gag	120
MC KALLUP, Orthodontic Plar	178
MEAD, Extracting Forceps	25
MEAD, Bone File	119
MEAD, Bone Remover	171
MEAD, Root Elevator	42
MEAN, Periodontal Instruments	115
MERRIAM, Gum & Drawing Plar	82
MERRITT	88
MERRITT, Probes	80-80
METZENBAUM, Scissors	155
METZENBAUM (CAREY) Operating Sucker	148
METZENBAUM Operating & Drawing Sucker	150
METZENBAUM SEM Operating & Drawing Sucker	100-155
MICRO-BOISSARD	60
MILLER-APPEL, Root Elevator	34
MILLER, Bone File	117
MILWAUKEE, Extracting Forceps	20
MILLENER, Gum Sucker & Gouge	135
MITCHELL, Scaler	58
MOD-BERLIN, Frig Instruments	85
MOD-MARTIN, Root Elevator	170
MOD-MARTIN, Tongue Depressor	171
MOD-USA, Bone Curved	137
MON-FOST, Orthodontic Plar	182
MORITZ-SCHNIGT, Tongue Depressor	128
MORSE, Gum Root Instrument	88
MORTIMER, Frig Instruments	84
MOLT-Perforated Instruments	115
MOLT, Mouth Gag	124
MOUTH-SPRINT & HANDLES	122-123
MUEHLMANN, Scaler	80

N

NEVILLE, Extracting Forceps	25-28
NIRO, Gum Sucker	164
NYSTRÖM, Gum Sucker	88

O

OSCHENBERG, Bone Chisel & Gouge	154
OSGUTH-HEAGER, Needle Holder	147
OPERATING-BOISSARD	144-145-146-147
OREAN, Periodontal Instruments	87-88
ORTHODONTIC PLIERS	175-185
OSTEOMES, Root Sucker	168

INDEX

ELMED
 INSTRUMENTS

P

PALMER, Patient Gown Clasp Frame	162
PAMBY, E-Tracking Forceps	23
PARTSCH, Bitts	107
PARSICH	116
PEEGL, Osteosynthetic Plier	168
PEET, Spinal Forceps	32
PERMY, Crown & Dressing Plier	63
PERIQUIONI, A. Sr. Complete	66
PERIOSTEAL ELEVATORS	112
PWYSICK, Extracting Forceps	21
PK THOMAS, Curved Instrument	67
PLASTER RIMMED	103
POLYOFF, Bone Plier	117
POTL, Root Device	48
RECHARD, Protractor	115
PROBES & EXPLORERS	73-74-75-76

Q

QUINRY, Gauze Towels	164
----------------------	-----

R

RALPH, Spinal Forceps	32
ROACH, Curved Instruments	66
ROOT Spinal Forceps	\$1.32
ROOT CANAL SPREADER	79
ROSER-MONRO, Root Saw	124
ROBBIE DANKMANN ROSSERS & OLAND	163-164-165
RUBEN, Bone Rasp	175

S

SARVERINO, Gauze Towels	162
SCALERS	64
SCALPED HANDLES	133-134
SCHUMMER, Root Extractor	46
SCHWARZ, Chisel/Scalpel	176-178-181
SEEMANN-BOFFERT, Neurology	127
SELDIN, Root Extractor	33
SELDIN, Retractor	116
SEYFELD (JACKET), Root Device	43
SIMPLEX, Retainer	128
SKULL-LIFT COURETTES	110-111
SISTRUNK, Operating & Dressing Scissors	149
SLIM, Gauze Towels	162
SPATULAS	104-105
SPENCER, Retainer	169
STENBERG, Retainer	128
STIKSA	12
STRUZZI, Spinal Instrument	21
STOCKES, Rubber Dam Clamp Frame	162

T

THOMAS, Extracting Forceps	24
THORNTON	81
TOPOLD, Tongue Depressor	129
TOFFLENN	167
TONGUE DEPRESSOR	130-131
TUMMERTEN-CARRER STAPLERS	156-157

U

UNIVERSITY MICHIGAN	89
UNIVERSAL SCISSOR	167-168
UNIVERSAL, Bone Forceps	171
USA-ROCELL, Osteosynthetic Plier	169

V

VEFE, Curving Instruments	80
VERTICAL CONDENSER	80
VOLLMANN, Bone Clasp	136

W

WALL, Bone Plier	118
WALFRIED, Bone Chisel & Gage	114
WALTSCHS, Osteosynthetic Plier	161
WALTER-FARMY, Root Extractor	39
WALTON, Retractor	143
WALLS, Filing Instruments	88
WARD, Amalgam Contactor	63
WARKYCK-JAMES, Root Extractor	49
WAX KNIFE	102
WEBSTER, Retraitor	172-142
WEICKSTAET, Amalgam Contactor	94
WEDLTAEGT, Amalgam Instrument	72
WESTCOTT, Bone Cutter	100
WESTON, Probes & Explorers	79
WHITE, Curving Instruments	80
WHITEHEAD, Root Saw	127
WHITE, Retraitor	50
WHITE, H-Unit Clamp Forceps	162
WHITE, Filing Instruments	85-86
WHITE, Probes & Explorers	76
WHITESIDE, Retraitor Instruments	60
WIEDER, Tongue Depressor	129
WILLINGER	116
WILLIAMS, Protractor Instrument	89
WILLIAMS-GOLDMAN FOX, Protractor Frame	71
WILLIAMS, Filing Instruments	88
WILDER, Bone Clasp	137
WINTER, Root Extractor	49
WISDOM-Moachler, Extracting Forceps	14
WITZEL, Root Spinal Forceps	31
WOODSON, Filing Instruments	86-87
WOODWARD	79
WRIGHT (DEFF), Needle Holder	138-140

Y

YOUNG, Tongue Holding Forceps	72
YOUNGER-GOOD, Retraitor	67
YOUNG, Osteosynthetic Plier	161

Z

ZANCE, Curving Instruments	80
ZURICH, Probes & Explorers	74

ELMED
INSTRUMENTS



ELMED
INSTRUMENTS

P.O.BOX # : 1656, RORAS ROAD, NOWL, SIALKOT - PAKISTAN

Tel: +92-52-3552944, 3550244, 3557728-9

Fax: +92-52-3557730, 3558830

E-mail: info@elmedinstruments.com

Web: www.elmedinst.com